

# CAISSON BAS 400

## A

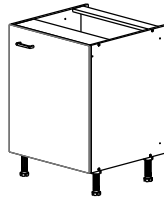

## B

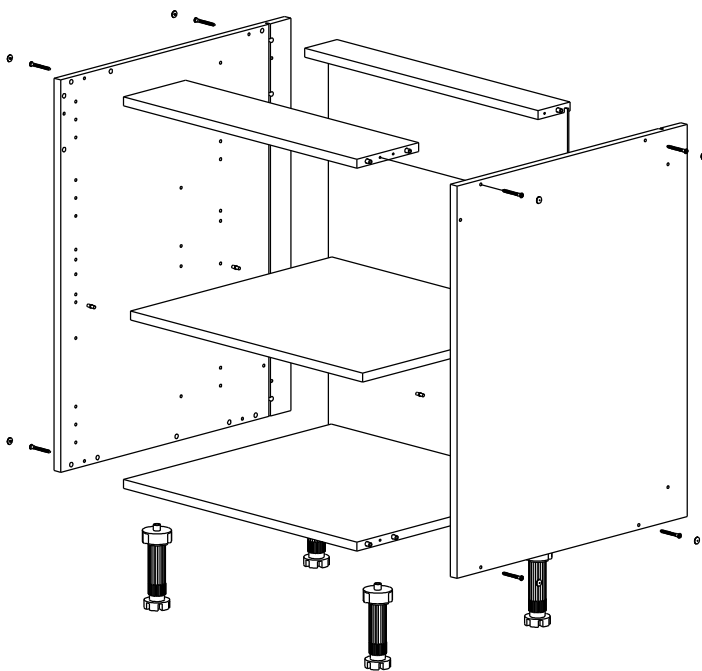
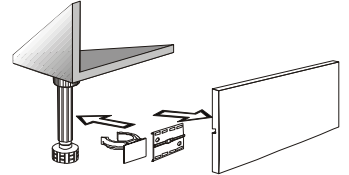
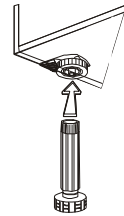
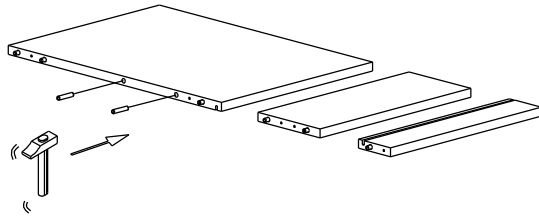
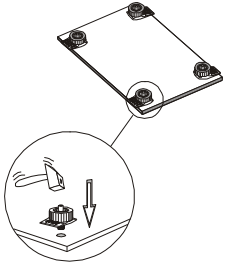
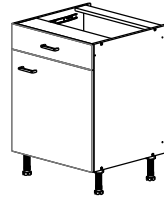

**A** FAÇADE

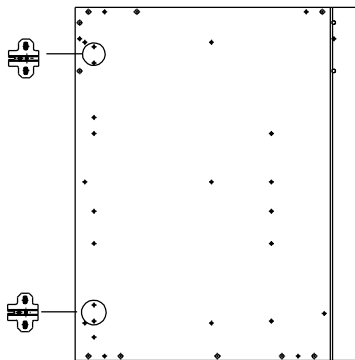





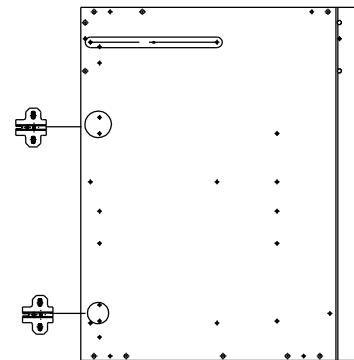
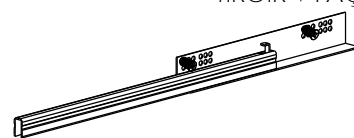













**B**

TIROIR + FAÇADE



EMB3523500

 4	 2	 2	 2	 8	 2	 2	 4	 4	
 16	 8	 4	 2	 8	 2	 2	 4	 4	