

WifiGate

Module récepteur connecté pour motorisation

Receiver module connected for motorisation
Modulo ricevitore collegato per la motorizzazione
Módulo receptor conectado para motorización

AAM0125

WiFiGate



Commande les
motorisations
à distance



Compatible
multi-marques



Contrôle par
la voix

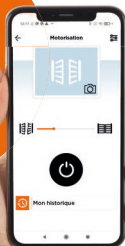

Notice d'utilisation et d'installation



Installation and user manual



Manuale d'installazione e uso



Instrucciones de uso e instalación

V.102023 - IndA

SOMMAIRE

A- Précautions d'utilisation	2
B- Descriptif	2
C- Câblage / Installation	3
D- Configuration de l'application	6
E- Paramètres.....	10
F- Caractéristiques techniques.....	15
G- Assistance technique.....	16
H- Garantie.....	16
I- Avertissements	17
J- Déclaration de conformité.....	17

A- PRÉCAUTIONS D'UTILISATION

Ce manuel fait partie intégrante de votre produit. Ces instructions sont pour votre sécurité. Lisez-les attentivement avant utilisation et conservez-les pour une consultation ultérieure. Ne pas brancher votre alimentation tant que votre installation n'est pas terminée et contrôlée. La mise en œuvre, les connexions électriques et les réglages doivent être effectués dans les règles de l'art par une personne qualifiée et spécialisée et dans le respect des normes en vigueur. Ce produit doit être installé dans un lieu sec. Vérifier que ce produit est utilisé uniquement pour l'usage auquel il est destiné. Ce produit fonctionne avec l'application iSCS Sentinel uniquement. L'application est disponible gratuitement sur le PlayStore et l'AppStore. Les mises à jour de l'application peuvent être nécessaires, par exemple pour corriger des bugs, améliorer des fonctionnalités, et bénéficier d'une meilleure expérience utilisateur. Vous pouvez activer ou désactiver le caractère automatique des mises à jour de l'application iSCS Sentinel dans les paramètres du PlayStore ou de l'AppStore. Les informations concernant la raison de la mise à jour, son impact sur les performances et l'évolution des fonctionnalités du produit ou de l'application ainsi que l'espace de stockage utilisé, sont indiquées, pour chaque mise à jour, sur le PlayStore ou l'AppStore.

Conformément à la réglementation et la garantie légale, la disponibilité de l'application et de ses mises à jour est garantie pour une durée de 2 ans.

Cette notice peut être amenée à évoluer selon les mises à jour de l'application. Afin d'être sûr d'avoir la dernière version, nous vous conseillons de la télécharger sur notre site internet www.scs-sentinel.com

B- DESCRIPTIF

Contenu du kit

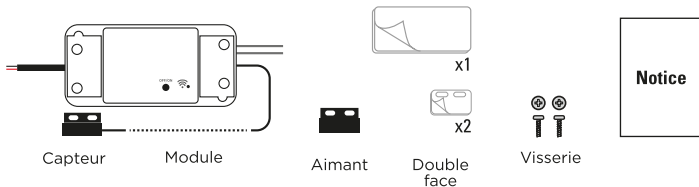

Présentation du produit

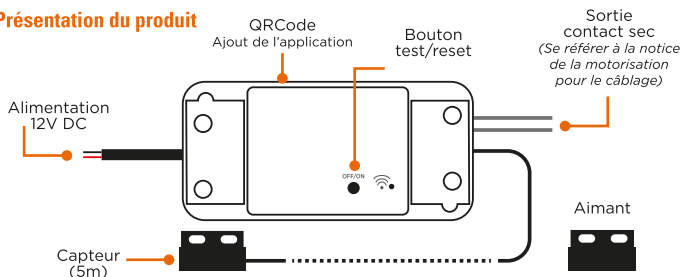

C- CÂBLAGE / INSTALLATION

⚠ Certains matériaux peuvent réduire la portée du signal Wi-Fi. Si besoin, il est recommandé de déplacer le module pour assurer une meilleure réception du signal.



Le module doit être installé en intérieur soit dans le coffret de la motorisation de portail soit dans une boîte de dérivation étanche.

C1- Installation pour portail coulissant

Avant d'installer le module, le portail doit être en position fermée.

Fixer l'aimant sur le portail et le capteur sur la motorisation. Laisser un espace de 15 mm maximum entre l'aimant et le capteur (ils ne doivent pas se toucher).

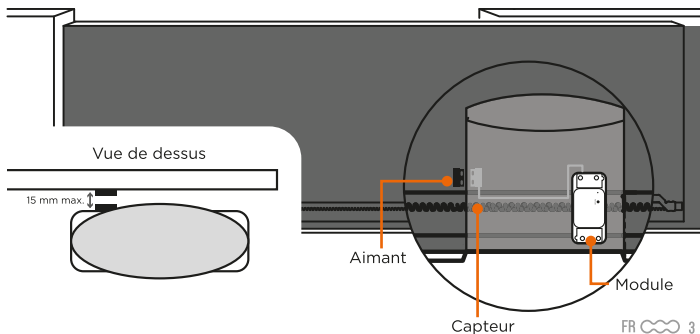

C2- Installation pour portail battant

Avant d'installer le module, le portail doit être en position fermée. Fixer le capteur sur le battant du côté de la carte électronique et l'aimant sur l'autre battant. Laisser un espace de 15 mm maximum entre les aimants (ils ne doivent pas se toucher).

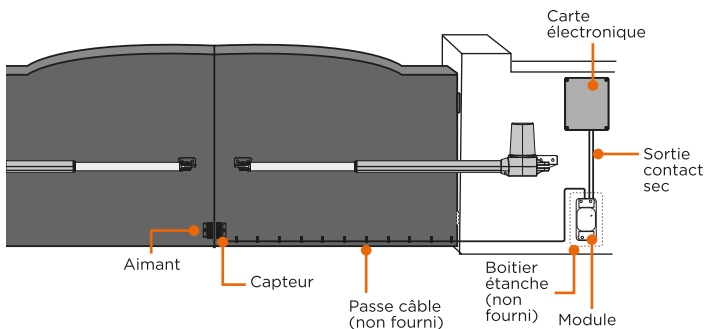

C3- Installation pour porte de garage

Avant d'installer le module, la porte doit être en position fermée. Fixer l'aimant en bas de la porte puis le capteur au même niveau (face à face). Laisser un espace de 15 mm maximum entre les aimants (ils ne doivent pas se toucher).

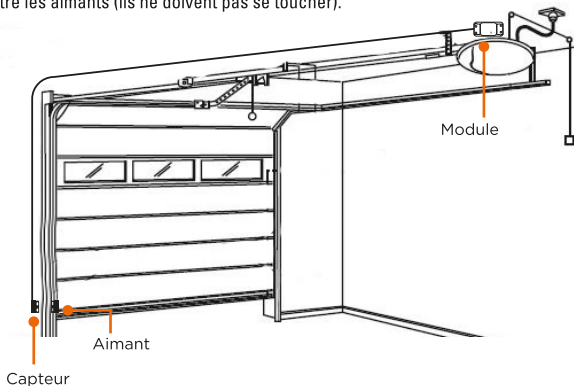

Le module indique si le portail / la porte est fermé(e) ou non fermé(e) grâce à l'aimant et au capteur.

 **Portail / porte OUVERT(E) :**

Le capteur ne détecte plus l'aimant. L'application indique que le portail n'est pas fermé. Il peut être ouvert complètement, ou ouvert partiellement, ou en cours d'ouverture ou de fermeture.

 **Portail / porte FERMÉ(E) :**

Le capteur détecte l'aimant. L'application indique que le portail / la porte est fermé(e) complètement.

IMPORTANT : Le signal contact sec est le même pour un déclenchement d'ouverture ou un déclenchement de fermeture.

Le module prendra en compte la dernière demande, selon la position des récepteurs, pour afficher l'information sur l'application.

Il est possible que le portail / la porte fasse un mouvement inverse par rapport à l'indication sur l'application. Il est important d'attendre la fin de l'animation de l'application pour connaître l'état réel du portail / la porte (fermé(e) ou non fermé(e)).

D - CONFIGURATION DE L'APPLICATION

D1 - Installation de l'application



iSCS Sentinel

Pour télécharger l'application, connectez-vous sur l'App Store ou le Play Store de votre smartphone. Rechercher «iSCS Sentinel», cliquer ensuite sur Installer.



Lorsque le téléchargement est terminé, ouvrir l'application et cliquer sur créer mon compte.



Renseigner l'adresse mail ainsi que le mot de passe dans les cases correspondantes.

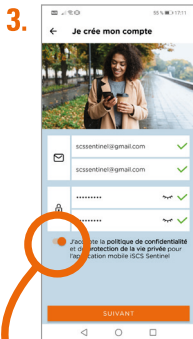

Appuyer sur suivant.



Il est nécessaire d'accepter la politique de confidentialité avant de cliquer sur suivant.

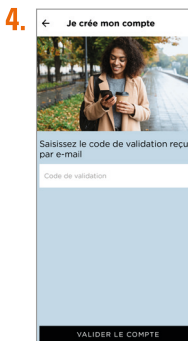

Renseigner le code de validation reçu par mail. Puis valider le compte.

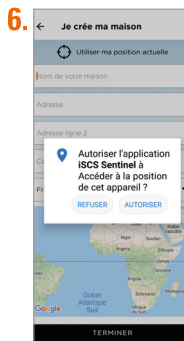
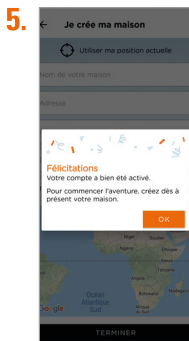

Appuyer sur AUTORISER.

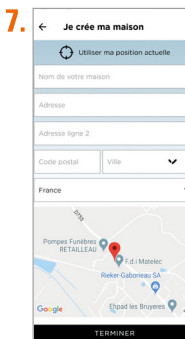

Renseigner toutes les informations demandées pour créer la maison. Puis cliquer sur terminer.

D2- Ajouter le produit

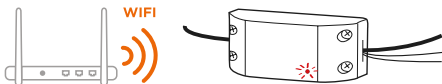

Brancher le module et placer-le à proximité du routeur Wi-Fi. Le téléphone doit être connecté au même réseau Wi-Fi que le module et la localisation doit être activée.

Certains matériaux peuvent réduire la portée du signal Wi-Fi.

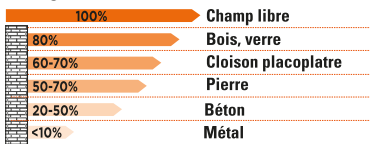

Appuyer sur puis sur NOUVEL APPAREIL pour ajouter le produit



Renseigner la clé Wi-Fi et flasher le QR Code du produit ou entrer le code manuellement.



Le réseau doit être en 2.4 GHz pour fonctionner.

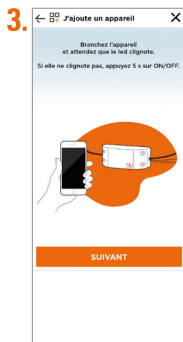

Brancher l'appareil et attendre que la LED clignote. Si elle ne clignote pas, appuyer 5 sec sur le bouton ON/OFF. Appuyer sur SUIVANT



Appuyer sur

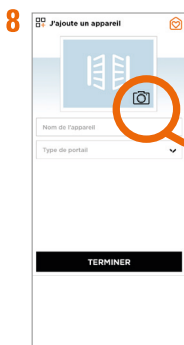

Nommer le module et choisir le type de portail.



Ajouter une photo de profil à partir de l'appareil photo, de la galerie ou sélectionner une image par défaut (visuel du produit)

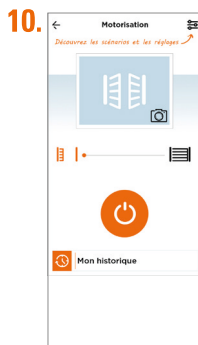



En cas d'échec lors de la connexion de l'appareil au Wi-Fi, une page d'erreur apparaît.

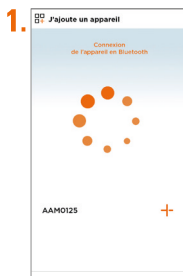

«répéter l'opération» : fait revenir à la 2^{ème} étape.



Si «répéter l'opération» ne fonctionne pas, appuyer sur «autre méthode»

Vérifier ces 5 points.



Utiliser «AP pairing»



Connecter le téléphone au point d'accès Wi-Fi de l'appareil.



Clignote lentement : AP pairing

Clignote rapidement : Bluetooth pairing

E- PARAMÉTRAGE

●●● Réglage de l'application



Appuyer sur  pour accéder aux réglages de l'application.



Voir mon profil :
Pour modifier les informations personnelles.

Pour ajouter une maison

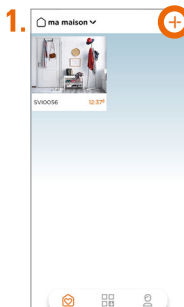

Cliquer sur +



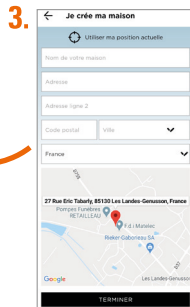

Créer une nouvelle maison.



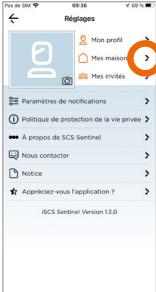

Renseigner les champs et appuyer sur «TERMINER».

Pour supprimer une maison

- 

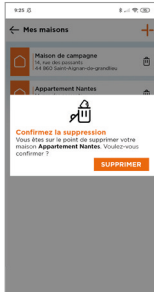

1. Appuyer sur .
- 



2. Appuyer sur  pour supprimer une maison.
- 

3. Appuyer sur  pour confirmer la suppression.

Pour modifier une maison

- 

1. Appuyer sur .
- 

2. Appuyer sur  pour modifier l'adresse.
- 

3. Appuyer sur  pour enregistrer les modifications.

Paramètres de notifications

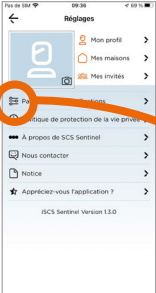
- 

1. Appuyer sur  pour accéder aux paramètres de notifications.
- 

2. Appuyer sur «Activer les notifications» pour activer la totalité des notifications. Sinon appuyer sur les notifications souhaitées.

Utilisation de l'application



Témoin

Appuyer pour ouvrir ou fermer la motorisation

Supprime l'historique

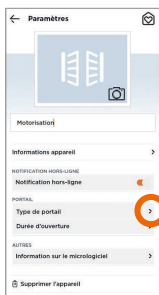

Sélectionner le type de portail

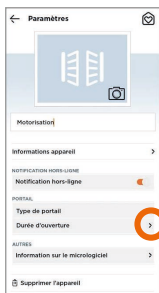
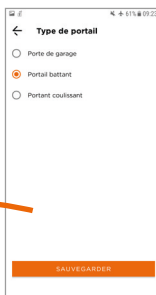

Définir la durée d'ouverture du portail

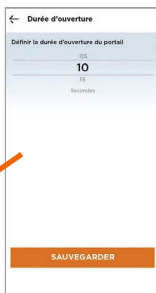



Exemple :
J'ouvre mon portail
les jours de la semaine
à 8H.

1.

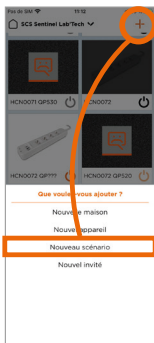

2.

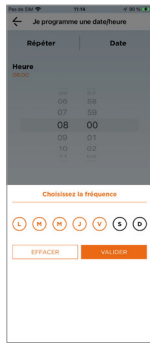

Pour sélectionner un ou des événements déclencheurs (appareil, date/heure ou lieu) appuyer sur +

3.

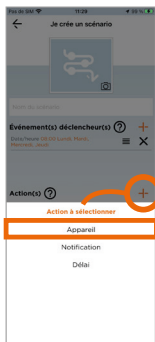

Pour sélectionner une ou des actions (appareil, notification ou délai) appuyer sur +

4.



Par défaut, le scénario apparaît dans la liste des favoris.

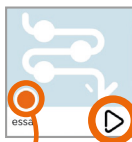

Le scénario est activé

Activer les «actions» du scénario sans attendre les «événements déclencheurs»

●●● Ajouter des invités

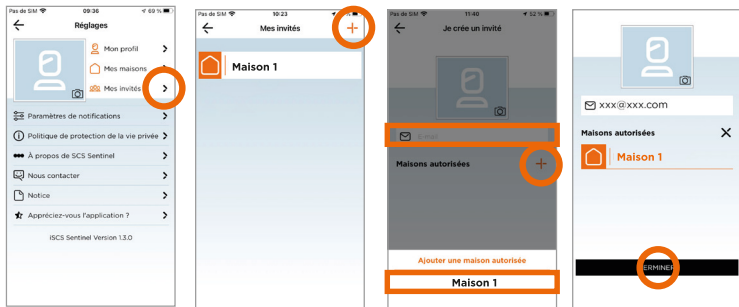

⚠ Via l'application **iSCS Sentinel**, un invité peut activer / désactiver les appareils mais il ne peut pas les paramétrer.

●●● Pilotage avec les assistants vocaux



Avant de commencer, s'assurer que l'appareil est connecté à l'application iSCS Sentinel, que l'assistant vocal est relié à Internet et qu'il fonctionne correctement (poser une question pour vérifier).

●●● Google Assistant

- Ouvrir l'application Google Home 
- Cliquer sur l'icône « + », puis : Configurer un appareil / Fonctionne avec Google et choisissez iSCS Sentinel
- Entrez les identifiants utilisés pour se connecter à l'application iSCS Sentinel
L'assistant vocal va rechercher les appareils disponibles et les afficher dans la liste des appareils dans l'application Google Home. Si ce n'est pas le cas dites à votre assistant vocal "OK Google, synchronise les appareils".

●●● Alexa

- Ouvrir l'application Alexa 
- Choisir Skills puis choisir iSCS Sentinel
- Entrer les identifiants utilisés pour se connecter à l'application iSCS Sentinel
L'assistant vocal va rechercher les appareils disponibles et les afficher dans la liste des appareils dans l'application Alexa.

	 Google Assistant	 Alexa
Ouvrir le portail	« Ouvre <i>portail*</i> » + code PIN	« Ouvre <i>portail*</i> » + code PIN
Fermer le portail	« Ferme <i>portail*</i> »	« Ferme <i>portail*</i> »

* Nom à paramétrer sur l'application

●●● Reset

Pour réinitialiser le module, appuyer et maintenir le bouton durant 10 sec. Cette opération supprimera l'appairage du module à votre réseau Wi-Fi.

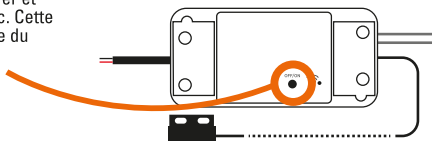

Pour totalement supprimer l'appareil il faudra le supprimer dans l'application.

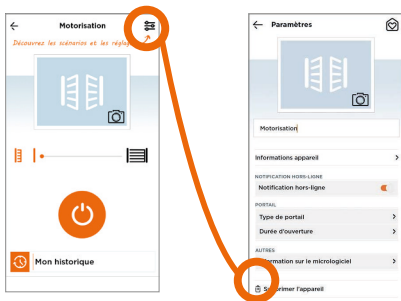

F- CARACTÉRISTIQUES TECHNIQUES

Module connecté

Alimentation	12V DC 1000mA
Fréquence de fonctionnement	2412MHz ~ 2472MHz / 2402MHz ~ 2480MHz
Puissance maximale d'émission	< 100mW
Température de fonctionnement	-10°C ~ +40°C
Dimensions	88 x 40 x 23 mm

G- ASSISTANCE TECHNIQUE

Aide au dépannage

Problème rencontré	Solutions
Si l'ajout du module échoue	<ul style="list-style-type: none">- Vérifier que l'alimentation est bien branchée et que la LED s'allume ou clignote- Vérifier que vous êtes bien connecté en Wi-Fi- Lorsque vous tapez le mot de passe Wi-Fi, ne pas taper les espaces.- Vérifier que vous avez bien saisi le mot de passe Wi-Fi- Vérifier que votre box est bien connectée à Internet- Assurez-vous d'avoir un débit suffisant- Vérifier que votre smartphone est sur le même réseau que celui renseigné dans l'application- Vérifier que le réseau Wi-Fi sur lequel vous essayez de vous connecter est bien en 2.4GHz et non en 5GHz.- Faire l'appairage à moins de 3 m de la box Wi-Fi

Conseils d'expert

En cas de besoin, vous pouvez prendre contact avec nos experts au numéro ci-dessous. Notre équipe de techniciens et de techniciennes, basée en France, assure un conseil avisé et personnalisé.



0 892 350 490

Service 0,15 € / min
+ prix appel

Horaire du service, voir sur le site internet : scs-sentinel.com/contact

Nous vous demandons au préalable de relever la référence de votre matériel sur la notice ou l'emballage de votre produit. Nous vous conseillons également de brancher votre matériel « en fils volants » sur une table après avoir démonté les éléments.

Chat' en ligne



Une question ?

Pour une réponse personnalisée, utilisez notre chat' en ligne sur notre site web www.scs-sentinel.com

H - GARANTIE



Garantie 2 ans, conformément à la réglementation Française en vigueur. Conservez soigneusement le code-barre ainsi que votre justificatif d'achat, il vous sera demandé pour faire jouer la garantie.
Il est impératif de garder une preuve d'achat durant toute la période de garantie.

Ne sont pas couverts par la garantie :

- Dommages matériels ou électriques résultant d'une mauvaise installation.
- Dommages résultant d'une utilisation impropre (utilisation différente de son origine) ou de modifications.
- Dommages résultant de l'utilisation et/ou installation de pièces ne provenant pas de celles prévues et incluses par SCS Sentinel.
- Dommages dûs à un manque d'entretien ou un choc.
- Dommages dûs aux intempéries telles que : grêle, foudre, vent violent, etc.
- Retours articles sans copie de facture ou justificatif d'achat.

I - AVERTISSEMENTS

- Ne pas approcher l'appareil de flammes nues, telles que des bougies allumées.
- Le fonctionnement normal du produit peut être perturbé par une forte interférence électromagnétique.
- Cet équipement est destiné à un usage privé uniquement.
- L'appareil ne doit pas être exposé à des égouttements d'eau ou des éclaboussures. Aucun objet rempli de liquide tel que des vases ne doit être placé sur l'appareil.
- L'ensemble des éléments doit être utilisé en intérieur.
- Les éléments étant composés d'électronique, ils sont à manipuler avec précaution.
- Lors de l'installation de votre produit, ne pas laisser les emballages à la portée des enfants ou des animaux. Ils représentent une source potentielle de danger.
- Ce produit n'est pas un jouet. Il n'a pas été conçu pour être utilisé par des enfants.



Avant tout entretien, débrancher vos appareils. Ne pas nettoyer le produit avec des solvants, des substances abrasives ou corrosives. Utiliser un simple chiffon doux. Ne rien vaporiser sur le produit.



Assurez-vous de la bonne maintenance de votre produit et vérifiez fréquemment l'installation pour déceler tout signe d'usure. N'utilisez pas l'appareil si une réparation ou un réglage est nécessaire. Faites appel à du personnel qualifié.



Ne jetez pas les appareils et les piles hors d'usage avec les ordures ménagères. Les substances dangereuses qu'ils sont susceptibles de contenir peuvent nuire à la santé et à l'environnement. Utilisez les moyens de collectes sélectives mis à votre disposition par votre commune ou votre distributeur.



Points de collecte sur www.quefairedesdechets.fr
Privilégiez la réparation ou le don de votre appareil !

Signification des marquages :

 Courant continu

 Le produit est destiné à une utilisation intérieure uniquement



J- DÉCLARATION DE CONFORMITÉ

Par la présente, SCS Sentinel déclare que ce produit est conforme aux exigences essentielles et autres dispositions pertinentes de la directive 2014/53/UE. La déclaration de conformité peut être consultée sur le site : www.scs-sentinel.com/downloads.

CONTENTS

A- Safety warning	18
B- Description	18
C- Wiring / Installing	19
D- Configuring the application.....	21
E- Settings.....	25
F- Maintenance.....	30
G- Technical support	31
H- Warranty	31
I- Warnings	32
J- Declaration of conformity	32

A- SAFETY WARNING

This manual is an important part of your product. These instructions are designed to ensure your safety. Please read them carefully before use and keep them in a safe place for future consultation. Select a suitable location. Sure that nothing will block the screws and anchors being inserted in the wall. Do not connect it to the power supply until you have finished installing and checking it. A qualified, specialised professional must perform the set-up, configuration and electrical connection in accordance with industry standards. The product must be set up in a dry location. This product must only be used for its intended purpose.

This product only operates with the iSCS Sentinel application. The application is free to download from the PlayStore and AppStore. The application may require updates, including to fix bugs, improve features and improve the user experience. You can activate or deactivate the automatic iSCS Sentinel application updates in the PlayStore or AppStore settings. Information about the reason for the update, its impact on performance, changes to the product or application's features, and the storage space used is provided for each update on the PlayStore and AppStore.

In accordance with legal warranties and regulations, the application's availability and updates are guaranteed for a period of two years.

This manual may be amended as the application is updated. To ensure you have the latest version, we recommend you download it from our website www.scs-sentinel.com

B- DESCRIPTION

Kit contents

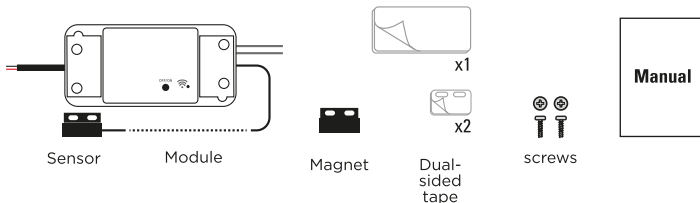

Components

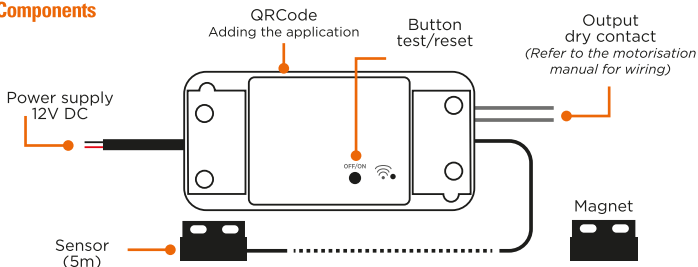

C- WIRING / INSTALLING

 Some materials may reduce the Wi-Fi signal's reach. You may need to move the control unit and accessories to obtain a better signal.



The module must be installed indoors, either in the gate operator cabinet or in a watertight junction box.

C1- Installation for sliding gates

Before installing the module, the gate must be in the closed position. Attach the magnet to the gate and the sensor to the operator. Leave a gap of no more than 15 mm between the magnet and the sensor (they must not touch).

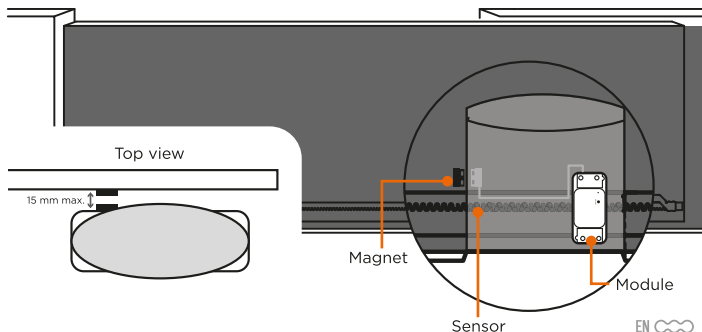

The module uses the magnet and sensor to indicate whether the gate/door is closed or not.

 **Gate / door OPEN :**

The sensor no longer detects the magnet. The application indicates that the gate is not closed. It may be fully open, partially open, or in the process of opening or closing.

 **Gate / door CLOSED :**

The sensor detects the magnet. The application indicates that the gate/door is fully closed.

IMPORTANT: The dry contact signal is the same for an opening trip or a closing trip.

The module will take account of the last request, depending on the position of the receivers, to display the information on the application.

The gate/door may move in the opposite direction to the indication on the application. It is important to wait until the end of the application animation to know the real state of the gate/door (closed or not closed).

D - CONFIGURING THE APPLICATION

D1 - Installing the app



iSCS Sentinel app

To download the app, go to AppStore or Play Store on your smartphone. Search for 'iSCS Sentinel', then click 'Install'.

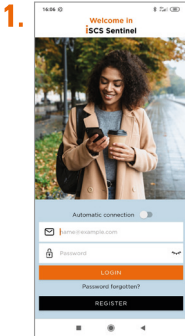

Once the app has downloaded, open it and click 'Create my account'.

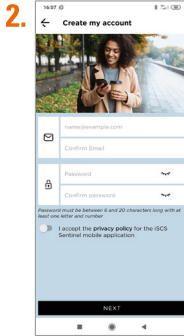

Enter your email address and password in the relevant fields.

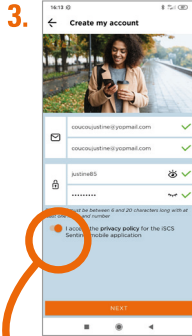

Click 'NEXT'.

You must accept the privacy policy before clicking 'next'.

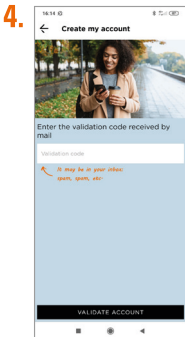

Enter the validation code you received by email. Then confirm the account.

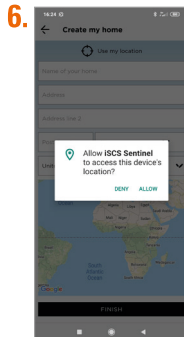
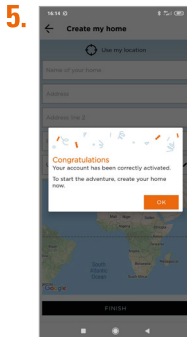

Click 'allow'.

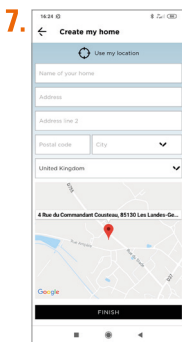

Enter all the information requested to create your home. Then click 'finish'.

D2- Adding a product

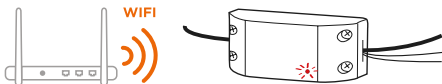

Turn the module and place it near a Wi-Fi router. Your smartphone must be connected to the same Wi-Fi network as the control unit and you must have your phone's location enabled.

 **Some materials may reduce the Wi-Fi signal's reach.**

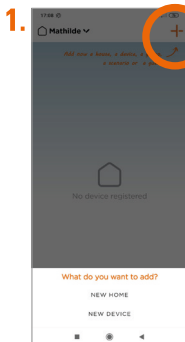
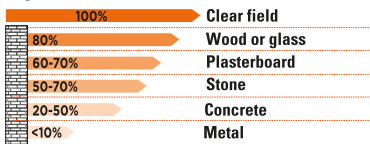

Click  then 'new device' to add the product.



Enter the Wi-Fi password and scan the product's QR code or enter the code manually.



The network needs to be 2.4 GHz to work.

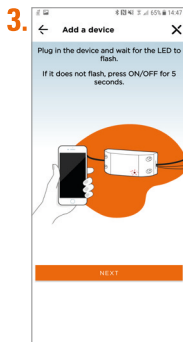

Plug in the device and wait for the LED to flash. If it does not flash, press ON/OFF for 5 seconds.

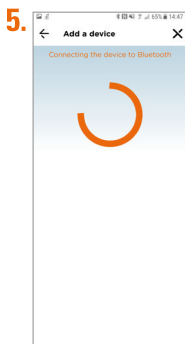

Click 

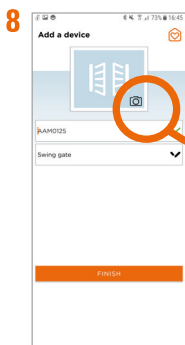
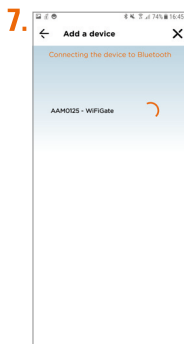

Name the module and room in which it is located.

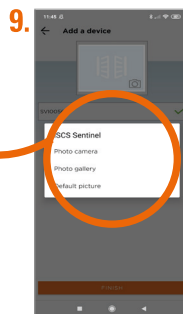

Add a profile photo using your smartphone camera, your photo gallery or a default picture (product picture).

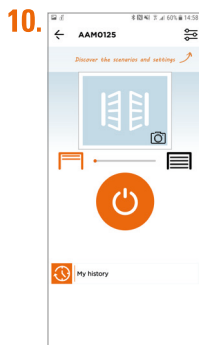

 **If the device fails to connect to Wi-Fi, an error page is displayed.**



'Repeat operation': takes you back to the second step.



If 'repeat operation' does not work, click 'other method'.

Check these five points.

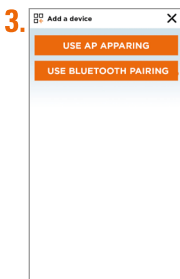

Use «AP pairing»



Connect the phone to the device's Wi-Fi access point.



Flashing slowly : AP pairing

Flashing quickly : Bluetooth pairing

E- SETTINGS

Configuring the application

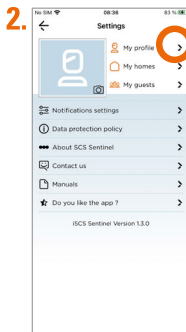
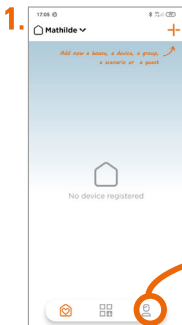

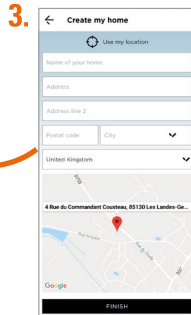
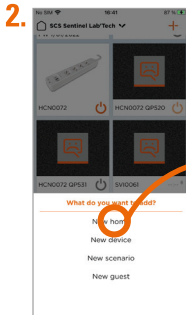
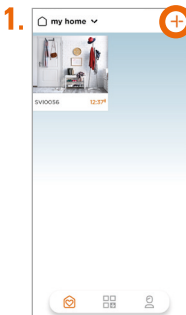

To add a home

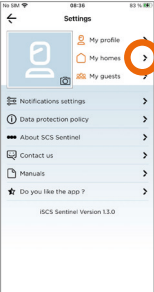

To remove a home

- 



1. Click  to access the homes list.
- 

2. Click  to delete a home.
- 

3. Confirm deletion. You are about to delete your home Mathilde. Do you want to confirm? 

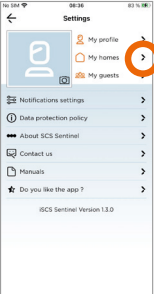
To edit a home

- 

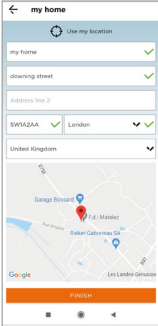

1. Click  to access the homes list.
- 

2. Click  to edit the address.
- 

3. Edit the address. 

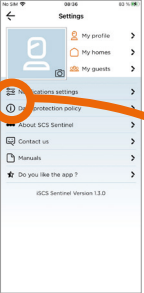
Notification settings

- 

1. Click  to access the notification settings.
- 

2. Click 'activate notifications' to activate all notifications. Otherwise, click on the desired notifications.

Using the app



Indicator

Press to open or close the gate

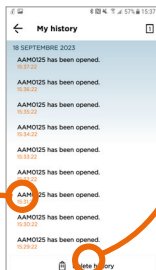

Delete history



Select gate type

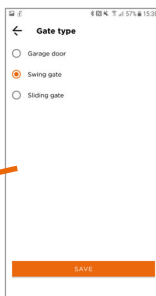

Set gate opening time of the gate



A scenario is an action that follows a triggering event(s):

- 1 Select the trigger event(s). If you have several triggers, you could combine them together (AND) or dissociate them to carry out the action (OR).
- 2 Define the action(s) to carry out.
- 3 Register your scenario.

Then, the app will start the scenario action(s) when the trigger would be detected.

NEXT

Example:
You open your gate every weekday at 8.00 am.

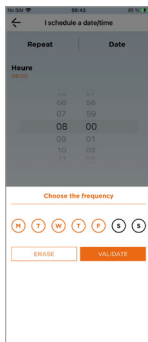
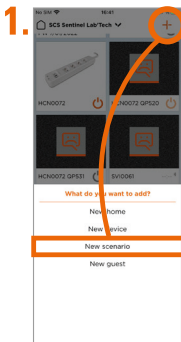

To select one or more trigger events (device, date/time or location) press +.

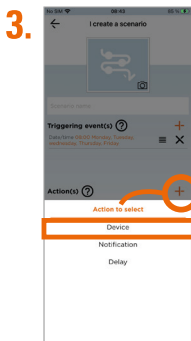

To select one or more actions (device, notification or delay) press +.

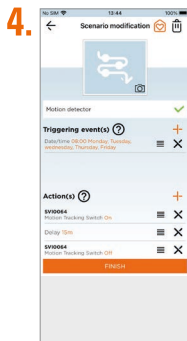

By default, the scenario will appear in the favorites list.





The scenario is activated

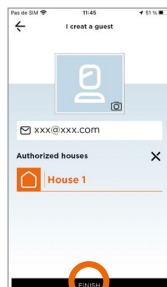
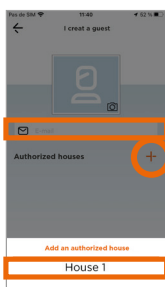
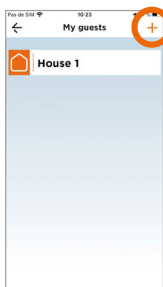
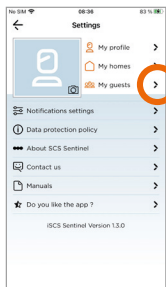

Activate the «actions» of the scenario without waiting for the «triggering events».

●●● To add guests



 Via the iSCS Sentinel app, your guest can activate/deactivate the devices but cannot configure them.

●●● Controlling with voice assistants



Before starting, ensure the device is connected to the iSCS Sentinel app, and the voice assistant is connected to the internet and working properly (ask it a question to check).

Google Assitant

- Open the Google Home app 
- Click +
then 'Configure a device/works with Google' and select iSCS Sentinel.
- Enter the login details used to log into the iSCS Sentinel app.
The voice assistant will search for available devices and display a list in the Google Home app. If that does not work, tell your voice assistant: "Okay Google, synchronise devices."

Alexa

- Open the Alexa app 
- Select 'Skills' then select iSCS Sentinel
- Enter the login details used to log into the iSCS Sentinel app.
The voice assistant will search for available devices and display a list in the Alexa app.

	 Google Assistant	 Alexa
Open the gate	« Open <i>gate*</i> » + PIN code	« Open <i>gate*</i> » + PIN
Close the gate	« Close <i>gate*</i> »	« Close <i>gate*</i> »

Reset

To re-pair the module, press and hold the button for 10 seconds. This operation will remove the pairing of the module to your Wi-Fi network.

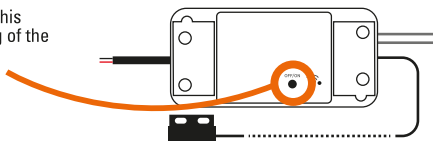

To completely remove the device, you will need to delete it from the app.

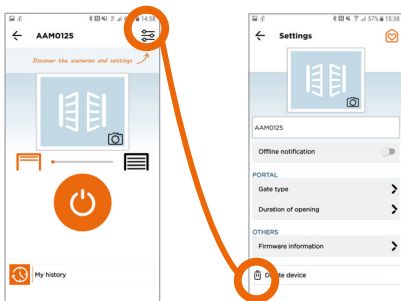

F- SPECIFICATIONS

Connected module

Power supply	12V DC 1000mA
Operating frequencies	2412MHz ~ 2472MHz / 2402MHz ~ 2480MHz
Maximum transmission output	< 100mW
Operating temperature	-10°C ~ +40°C
Dimensions	88 x 40 x 23 mm

G- TECHNICAL SUPPORT

Troubleshooting

Issue encountered	Solutions
The module cannot be added in the app	<ul style="list-style-type: none">- Check the power supply is properly connected and the Wi-Fi LED lights up or flashes- Check the Wi-Fi connection- Do not include spaces when entering the passcode- Check your Wi-Fi password is entered correctly- Check your router is connected to the internet- Check your smartphone has its location enabled- Make sure you have sufficient bandwidth- Check that your smartphone is connected to the same network entered in the app- Check that the Wi-Fi network is on 2.4 GHz and not 5 GHz- Pairing must be completed within 3 m of the Wi-Fi router

Online chat



Questions?

Use our online chat to get a personalised answer by visiting our website www.scs-sentinel.com

H- WARRANTY



Keep the barcode in a safe place, along with your proof of purchase.

If you claim under the warranty, you will be asked for these.

It is essential to keep your proof of purchase throughout the warranty period.

Not covered by the warranty:

- Material and electrical damage resulting from incorrect installation.
- Damage resulting from improper use (meaning not its intended purpose) or modifications.
- Damage resulting from the use and/or installation of parts not included or recommended by SCS Sentinel.
- Damage due to a lack of maintenance or an impact.
- Damage resulting from poor weather, such as hail, lightning or strong winds.
- Returns without a copy of the invoice or proof of purchase.

I- WARNINGS

- Keep the device away from naked flames such as burning candles.
- The products normal operation may be disrupted by strong electromagnetic interference.
- This equipment is intended for private use only.
- The device must not be exposed to splashes or drops of water. No liquid-filled objects, such as vases, should be placed on the device.
- All parts of the system must be used indoors.
- Handle the product parts carefully as they are electronic.
- When installing your product, do not leave packaging within reach of children or animals. It may pose a danger to them.
- This product is not a toy. It has not been designed for use by children.



Before performing any maintenance, disconnect your devices from the power supply. Do not clean the product with solvents or abrasive/corrosive substances. Simply use a soft cloth. Do not spray anything on the product. .



Ensure your product is well-maintained and frequently check the system to spot any signs of wear and tear. Do not use the device if it requires repairs or tuning. Contact a qualified professional.



Do not throw the devices or batteries out in your normal household waste. They may contain hazardous substances that could be harmful to human health and the environment. Use the special collection services provided by your local authorities or retailer.

Meaning of symbols:

--- Direct current



This product is intended for indoor use only



J- DECLARATION OF CONFORMITY

SCS Sentinel hereby declares that this product complies with the essential requirements and other relevant provisions of Directive 2014/53/EU. The declaration of conformity can be viewed online at: www.scs-sentinel.com/downloads.

INDICE

A- Precauzioni per l'uso	33
B- Specifiche.....	33
C- Cablaggio / Installazione	34
D- Configurazione dell'applicazione	37
E- Impostazione.....	41
F- Caratteristiche tecniche.....	46
G- Assistenza tecnica.....	47
H- Garanzia	47
I- Avvertenze	48
J- Dichiarazione UE di conformità.....	48

A- PRECAUZIONI PER L'USO

Il presente manuale costituisce parte integrante del prodotto. Queste istruzioni vengono fornite per vostra sicurezza. Siete pregati di leggerle con attenzione prima dell'uso e di conservarle per future esigenze di consultazione. Scegliere la posizione idonea. Verificare che non ci siano elementi che disturbano l'inserimento nel muro di viti e tasselli. Non collegare l'alimentazione prima di aver terminato e controllato l'installazione. L'installazione, i collegamenti elettrici e le regolazioni devono essere eseguiti a regola d'arte da un addetto qualificato e specializzato. L'unità di alimentazione deve essere installata in un luogo asciutto. Verificare che questo prodotto venga utilizzato esclusivamente per l'uso a cui è destinato.

Questo prodotto funziona solo con l'applicazione iSCS Sentinel. L'applicazione è disponibile gratuitamente su PlayStore e AppStore. Può essere necessario aggiornare l'applicazione, ad esempio per risolvere bug, migliorare la funzionalità e fornire una migliore esperienza all'utente. È possibile attivare o disattivare gli aggiornamenti automatici dell'applicazione iSCS Sentinel nelle impostazioni di PlayStore o AppStore. Informazioni sul motivo dell'aggiornamento, sul suo impatto sulle prestazioni e sull'evoluzione delle funzionalità del prodotto o dell'applicazione, nonché sullo spazio di archiviazione utilizzato, sono indicate su PlayStore o AppStore per ogni aggiornamento.

In accordo con la normativa e la garanzia legale, la disponibilità dell'applicazione e dei suoi aggiornamenti è garantita per un periodo di 2 anni.

Il presente manuale può essere soggetto a modifiche man mano che l'applicazione viene aggiornata. Per essere sicuri di avere l'ultima versione, consigliamo di scaricarla dal nostro sito web www.scs-sentinel.com

B- SPECIFICHE

Contenuto del kit

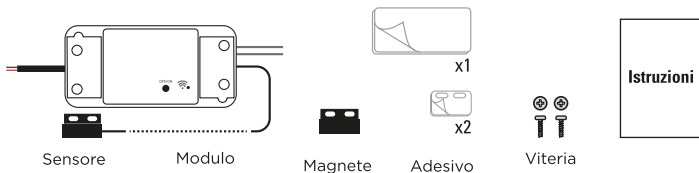

Presentazione del prodotto

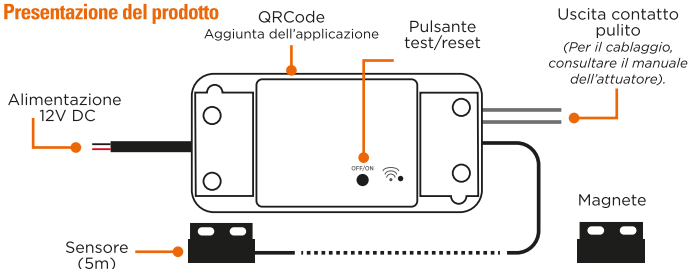

C- CABLAGGIO / INSTALLAZIONE

! Alcuni materiali possono ridurre la portata del segnale Wi-Fi. Se necessario, consigliamo di cambiare posizione alla centralina e agli accessori per garantire una migliore ricezione del segnale.



Il modulo deve essere installato all'interno, nell'armadio dell'operatore o in una scatola di giunzione a tenuta stagna.

C1- Installazione per cancello scorrevole

Prima di installare il modulo, il cancello deve essere in posizione chiusa.

Fissare il magnete al cancello e il sensore all'operatore. Lasciare uno spazio non superiore a 15 mm tra il magnete e il sensore (non devono toccarsi).

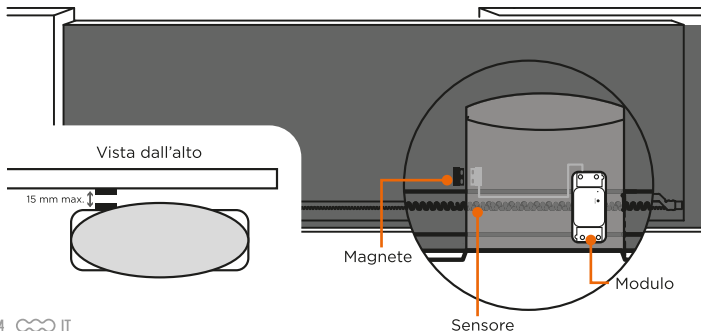

C2- Installazione per cancello a battente

Prima di installare il modulo, il cancello deve essere in posizione chiusa. Fissare il sensore all'anta sul lato della scheda elettronica e il magnete all'altra anta. Lasciare uno spazio massimo di 15 mm al massimo tra i magneti (non devono toccarsi).

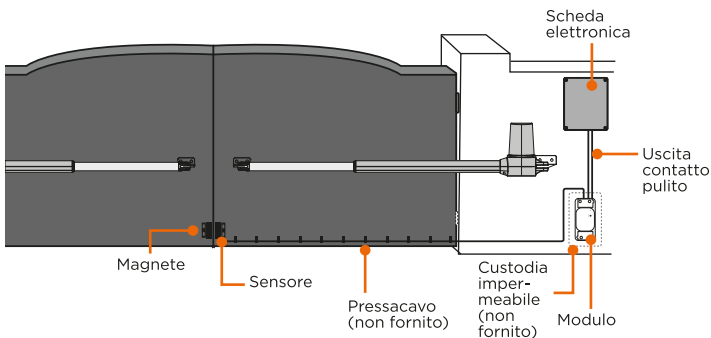

C3- Installazione per porta di garage

Prima di installare il modulo, la porta deve essere chiusa. Fissare il magnete nella parte inferiore della porta, quindi il sensore allo stesso livello (faccia a faccia). Lasciare uno spazio massimo di 15 mm tra i magneti (non devono toccarsi).

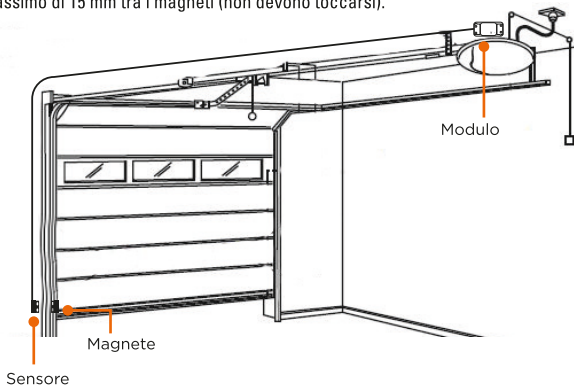

Il modulo utilizza il magnete e il sensore per indicare se il cancello/porta è chiuso o meno.

  **Cancello/porta APERTO :**

Il sensore non rileva più il magnete. L'applicazione indica che il cancello non è chiuso. Può essere completamente aperto, parzialmente aperto o in fase di apertura o chiusura.

  **Cancello / porta CHIUSO :**

Il sensore rileva il magnete. L'applicazione indica che il cancello/la porta è completamente chiuso.

IMPORTANTE: Il segnale del contatto pulito è lo stesso per un intervento in apertura o in chiusura.

Il modulo terrà conto dell'ultima richiesta, a seconda della posizione dei ricevitori, per visualizzare le informazioni sull'applicazione.

Il cancello/la porta può muoversi in direzione opposta all'indicazione sull'applicazione. È importante attendere la fine dell'animazione dell'applicazione per conoscere lo stato reale della porta (chiusa o non chiusa).

D - CONFIGURAZIONE DELL'APPLICAZIONE

D1 - Installazione dell'applicazione

4.



iSCS Sentinel

Per scaricare l'applicazione, accedere all'AppStore o al PlayStore dal proprio smartphone. Cercare iSCS Sentinel e cliccare su Installa.

1.



Quando il download è terminato, aprire l'applicazione e toccare su "Crea un account".

2.



Inserire l'indirizzo e-mail e la password nei campi corrispondenti

3.

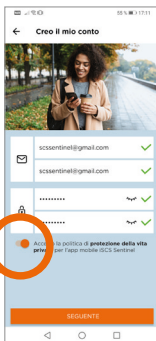

Toccare su "Avanti".

È necessario accettare l'Informativa sulla privacy prima di procedere.



4.



Inserire il codice di conferma ricevuto per e-mail. Confermare quindi l'account.

5.

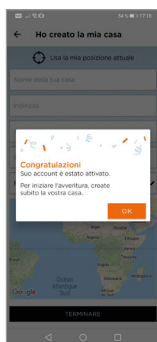

6.

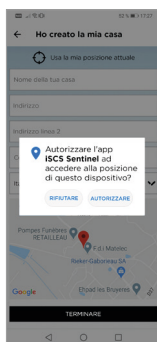

Toccare su "AUTORIZZA".

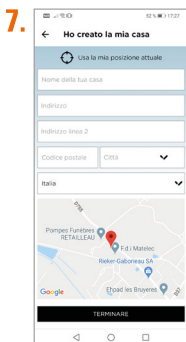

Inserire tutte le informazioni richieste per creare la casa. Quindi toccare su "TERMINA".

D2- Aggiungere il prodotto

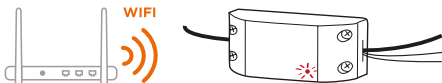

Collegare il modulo e posizionarlo accanto al router Wi-Fi. Lo smartphone deve essere connesso alla stessa rete Wi-Fi del modulo e la localizzazione di quest'ultima deve essere attivata.

⚠️ Alcuni materiali possono ridurre la portata del segnale Wi-Fi.

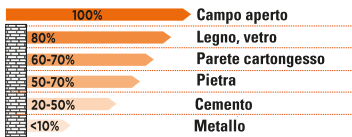

Premere su  e poi su "Nuovo dispositivo" per aggiungere il prodotto.

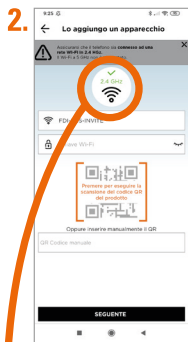

Inserire la chiave del Wi-Fi e scansionare il QR Code del prodotto, oppure inserire il codice manualmente.



La rete deve essere a 2.4 GHz per funzionare.

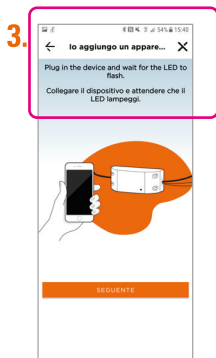

Collegare il dispositivo e attendere che il LED lampeggi. Se non lampeggia, premere il pulsante ON/OFF per 5 secondi.

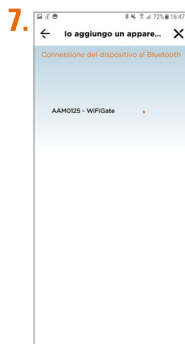
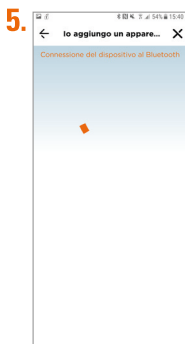

Toccare su +

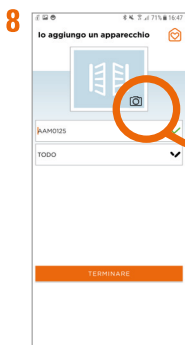

Assegnare un nome al modulo e selezionare il tipo di porta.

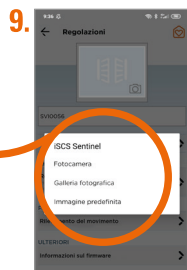

Aggiungere una foto del profilo del prodotto, galleria o selezionare un'immagine predefinita (visuale del prodotto)

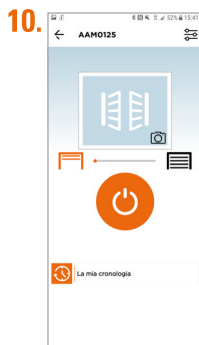



Se il dispositivo non riesce a connettersi al Wi-Fi, appare una pagina di errore.

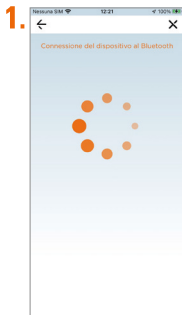

“Ripetere l’operazione”:
fa tornare indietro al
2° passaggio.



Se “Ripetere
l’operazione”
non funziona,
toccare su “Altro
metodo”.

Verificare questi 5 punti.

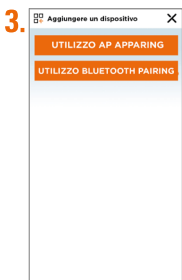

Utilizzare «AP
pairing»

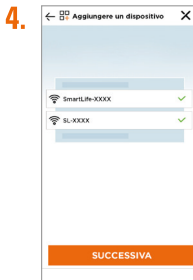

Collegare il
telefono al punto di
accesso Wi-Fi del
dispositivo.





Lampeggia
lentamente :
AP pairing

Lampeggia
rapidamente :
Bluetooth pairing

E- CONFIGURAZIONE

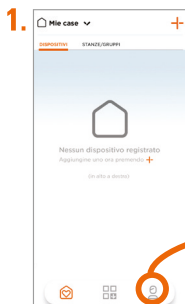
Impostazioni dell'applicazione



Premere su  per accedere alle impostazioni dell'applicazione.

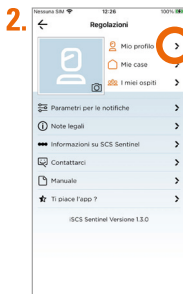

Verdere il profilo:
Per modificare i dati personali.

Per aggiungere una casa

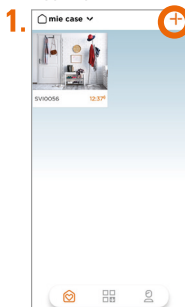

Toccare su  +



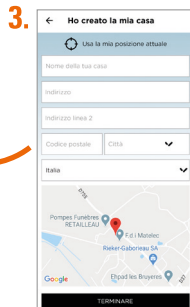

Creare una nuova casa.





Compilare tutti i campi e toccare su "Termina".

Per eliminare una casa

- 
- 

Toccare su per eliminare una casa.
- 

Per modificare una casa



- 
- 

Modificare l'indirizzo.
- 

Toccare su 

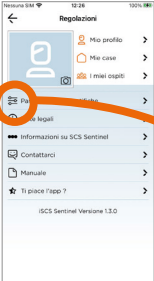
Impostazioni di notifica

- 

Premere su  per accedere alle impostazioni di notifica.
- 

Toccare su "Attivare le notifiche" per attivare tutte le notifiche. Oppure, selezionare le notifiche desiderate.

Uso dell'applicazione



Indicatore

Premere per aprire o chiudere l'attuatore



Cancellare storia



Selezionare il tipo di cancello

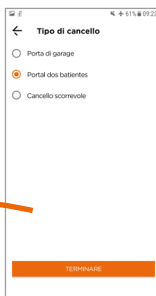

Impostare il tempo di apertura del cancello

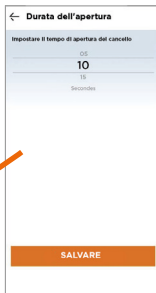

Un scenario est une action qui suit un/des événement(s) déclencheur(s).

- Sélectionnez le/les événements déclencheurs. Si vous avez plusieurs déclencheurs, vous avez le choix entre les combiner ensemble (ET) ou les disjoindre pour réaliser l'action (OU).
- Définissez le/les actions à réaliser .
- Enregistrez votre scénario. Ensuite, l'application lancera le/les actions du scénario, lorsqu'il aura repéré un déclencheur

SUIVANT

Esempio:
Apro il mio cancello nei giorni feriali alle 8 del mattino.



Per selezionare uno o più eventi di attivazione (dispositivo, data e ora, luogo), toccare su +.

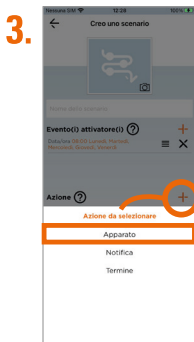

Per selezionare una o più azioni (dispositivo, notifica o tempo) toccare su +.

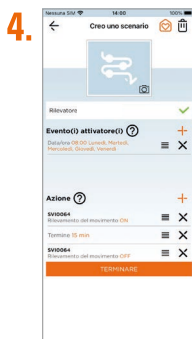

📌 Come impostazione predefinita, lo scenario figurerà nell'elenco dei preferiti.



Lo scenario è attivato.



Attivare le "Azioni" dello scenario senza attendere gli "Eventi di attivazione".

●●● Aggiungere invitati

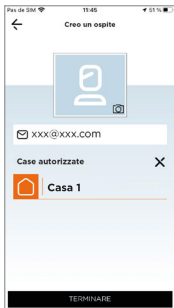
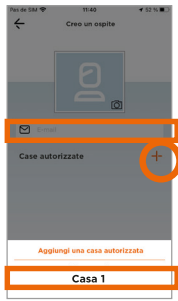
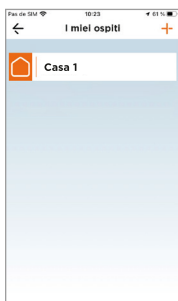

 Attraverso l'applicazione **iSCS Sentinel**, gli invitati possono attivare o disattivare i dispositivi ma non possono

●●● Controllo tramite gli assistenti vocali



Prima di cominciare, assicurarsi che il dispositivo sia connesso all'applicazione iSCS Sentinel, che l'assistente vocale sia collegato a internet e che funzioni correttamente (fare una domanda per verificare).

Google Assitant

- Aprire l'applicazione Google Home 
- Toccare su "+", poi: Configurare un dispositivo / Funziona con Google e selezionare iSCS Sentinel.
- Inserire il nome utente e la password utilizzati per accedere all'applicazione iSCS Sentinel. L'assistente vocale cercherà i dispositivi disponibili e li visualizzerà nell'elenco dei dispositivi nell'applicazione Google Home. In caso contrario, dire all'assistente vocale: "Ok Google, sincronizza i dispositivi".

Alexa

- Aprire l'applicazione Alexa 
- Selezionare Skills poi iSCS Sentinel
- Inserire il nome utente e la password utilizzati per accedere all'applicazione iSCS Sentinel. L'assistente vocale cercherà i dispositivi disponibili e li visualizzerà nell'elenco dei dispositivi nell'applicazione Alexa.

	 Google Assistant	 Alexa
Aprire il cancello	« Aprire <i>cancello</i> * » + codice PIN	« Aprire <i>cancello</i> * » + codice PIN
Chiudere il cancello	« Chiudere <i>cancello</i> * »	« Chiudere <i>cancello</i> * »

* Nome da impostare nell'applicazione

●●● Reset

Per accoppiare nuovamente il modulo, tenere premuto il pulsante per 10 secondi. Questa operazione rimuoverà l'associazione del modulo alla rete Wi-Fi.

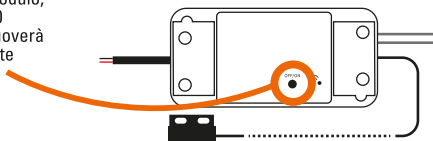

Per eliminare completamente il dispositivo, è necessario eliminarlo nell'applicazione.

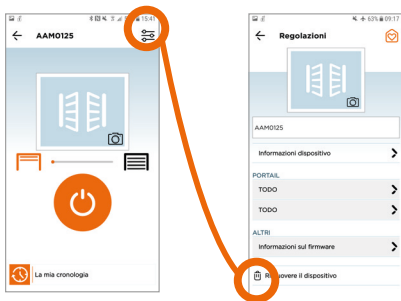

F- CARATTERISTICHE TECNICHE

Modulo collegato

Alimentazione	12V DC 1000mA
Frequenze di funzionamento	2412MHz ~ 2472MHz / 2402MHz ~ 2480MHz
Potenza massima di emissione	< 100mW
Temperatura di funzionamento	-10°C ~ +40°C
Dimensioni	88 x 40 x 23 mm

G- ASSISTENZA TECNICA

Supporto alla riparazione

Problema	Soluzioni
Non è possibile aggiungere il kit nell'applicazione.	<ul style="list-style-type: none">- Verificare che il dispositivo sia collegato e che il LED del Wi-Fi sia acceso o lampeggiante- Verificare la connessione Wi-Fi- Non inserire spazi bianchi digitando la password- Verificare che la password del Wi-Fi inserita sia corretta- Verificare che il modem sia collegato a internet- Verificare che la localizzazione del telefono sia attiva- Assicurarsi di avere campo sufficiente- Verificare che la rete dello smartphone corrisponda a quella indicata nell'applicazione- Verificare che la rete Wi-Fi sia su 2.4 GHz e non su 5 GHz- Accoppiare i dispositivi a meno di 3 m dal modem Wi-Fi

I consigli dell'esperto

I tecnici del servizio post-vendita sono disponibili in Italia al numero :



011-2339876

In caso di alfunzionamento del prodotto durante l'installazione o pochi giorni dopo la stessa si invita a contattare il servizio clienti rimanendo in prossimità del prodotto in modo da consentire ai nostri tecnici di diagnosticare subito l'origine del problema.

Chat online



Domande?

Per ottenere una risposta personalizzata è possibile utilizzare la nostra chat online sul sito web **www.scs-sentinel.com**.

H - GARANZIA



Garanzia di 2 anni, nel rispetto della legge francese attualmente in vigore. Conservare con cura il codice a barre e una prova di acquisto: sarà richiesta per poter applicare la garanzia.

È necessario conservare una prova di acquisto per tutto il periodo di garanzia.

La garanzia non copre:

- Danni materiali o elettrici derivanti da un'installazione non corretta.
- Danni derivanti da un uso improprio (uso diverso da quello originale) o da modifiche.
- Danni derivanti dall'uso e/o dall'installazione di pezzi diversi da quelli previsti e forniti da SCS Sentinel.
- Danni dovuti a una scarsa manutenzione o a urti.
- Danni dovuti a intemperie come grandine, fulmini, raffiche di vento, ecc.
- Restituzione di articoli senza copia della fattura o prova di acquisto.

I - AVVERTENZE

- Tenere il dispositivo lontano da fiamme libere (per es. candele accese).
- Il normale funzionamento del prodotto può essere disturbato da una forte interferenza elettromagnetica.
- Questo kit è destinato esclusivamente all'uso privato.
- Il dispositivo non dev'essere esposto a gocce o spruzzi d'acqua. Evitare di collocare oggetti contenenti liquidi (per es. vasi) sopra il dispositivo.
- Tutti gli elementi devono essere utilizzati all'interno.
- Gli elementi contengono componenti elettronici e devono essere maneggiati con cura.
- Durante l'installazione del prodotto, tenere gli imballaggi fuori dalla portata di bambini e animali. Rappresentano una potenziale fonte di pericolo.
- Questo prodotto non è un giocattolo. Non è destinato all'uso da parte dei bambini.



Prima della manutenzione, scollegare tutti i dispositivi. Non lavare il prodotto con solventi, sostanze abrasive o corrosive. Utilizzare un semplice panno morbido. Non spruzzare niente sul prodotto.



Assicurarsi della corretta manutenzione del prodotto e verificare spesso l'impianto per rilevare eventuali segni d'usura. Non utilizzare il dispositivo se sono necessarie riparazioni o regolazioni. Rivolgersi a personale qualificato.



Non smaltire i dispositivi e le pile usate con i rifiuti domestici. Le sostanze pericolose che possono contenere possono danneggiare la salute e l'ambiente. Utilizzare i mezzi di raccolta differenziata messi a disposizione dal proprio comune o distributore.

Significato dei simboli:

— — Corrente continua

~ Corrente alternata

 Modello di classe

 Il prodotto è destinato solo all'uso interno



J- DICHIARAZIONE UE DI CONFORMITÀ

Con la presente, SCS Sentinel certifica che il prodotto è conforme alle esigenze essenziali applicabili e in particolare alle esigenze della direttiva 2014/53/UE. La dichiarazione UE di conformità completa può essere consultata sul sito web: www.scs-sentinel.com/downloads.

ÍNDICE

A- Precauciones de uso	49
B- Descripción	49
C- Cableado / Instalación	50
D- Configuración de la aplicación	53
E- Configuración	57
F- Características técnicas	62
G- Asistencia técnica	63
H- Garantía	63
I- Advertencias	64
J- Declaración de conformidad	64

A- PRECAUCIONES DE USO

Este manual forma parte integral de su producto. Estas instrucciones son para su seguridad. Léalas atentamente antes de usar el producto y guárdelas para futuras consultas. Elija un lugar adecuado. Asegúrese de que no haya ningún elemento que impida la inserción de los tacos y los tornillos en la pared. No conecte la fuente de alimentación hasta que haya completado y comprobado la instalación. La instalación, las conexiones eléctricas y los ajustes debe realizarlos un especialista cualificado siguiendo las normas. La fuente de alimentación debe instalarse en un lugar seco. Asegúrese de que este producto se utiliza únicamente para el fin previsto.

Este producto solo funciona con la aplicación iSCS Sentinel. La aplicación está disponible gratuitamente en PlayStore y AppStore. Las actualizaciones de la aplicación pueden ser necesarias, por ejemplo, para corregir errores, mejorar la funcionalidad y proporcionar una mejor experiencia al usuario. Puede activar o desactivar las actualizaciones automáticas de la aplicación iSCS Sentinel en los ajustes de PlayStore o AppStore. La información sobre el motivo de la actualización, su impacto en el rendimiento y la funcionalidad del producto o la aplicación, así como el espacio de almacenamiento necesario, se proporciona para cada actualización en la PlayStore o la AppStore.

De acuerdo con la normativa y la garantía legal, la disponibilidad de la aplicación y sus actualizaciones está garantizada durante un periodo de 2 años.

Este manual puede estar sujeto a cambios en función de las actualizaciones de la aplicación. Para asegurarse de que tiene la última versión, le aconsejamos que la descargue de nuestro sitio web www.scs-sentinel.com

B- DESCRIPCIÓN

Contenido del kit

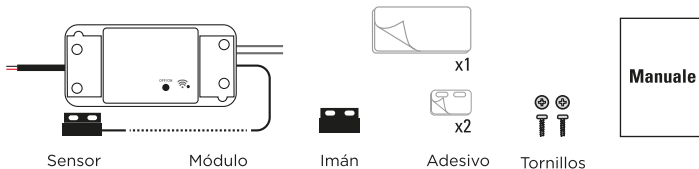

Presentación del producto

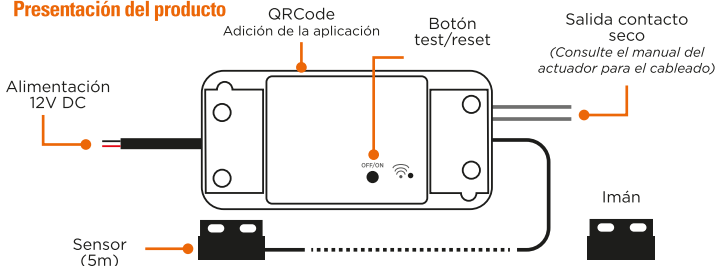

C- CABLEADO / INSTALACIÓN

⚠ *Algunos materiales pueden reducir el alcance de la señal Wi-Fi. En caso necesario, se recomienda desplazar la unidad central y los accesorios para garantizar una mejor recepción de la señal.*



El módulo debe instalarse en el interior, en la caja del automatismo o en una caja de conexiones estanca.

C1- Instalación para puerta corredera

Antes de instalar el módulo, la puerta debe estar en posición cerrada.

Fijar el imán a la puerta y el sensor al automatismo. Dejar un espacio no superior a 15 mm entre el imán y el sensor (no deben tocarse).

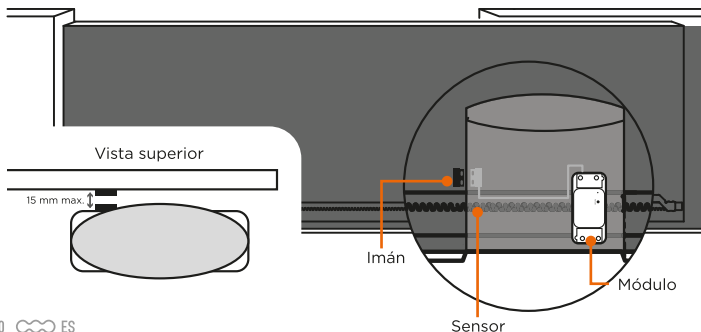

C2- Instalación para puertas batientes

Antes de instalar el módulo, la puerta debe estar en posición cerrada. Fijar el sensor a la hoja a más cerca de la caja electrónica y el imán a la otra hoja. Dejar un espacio de 15 mm como máximo entre los imanes (no deben tocarse).

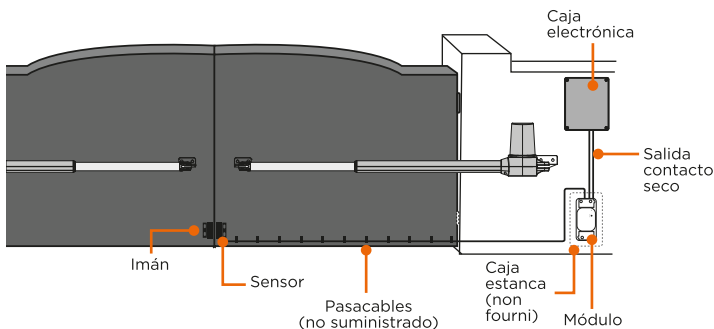

C3- Instalación para puerta de garaje

Antes de instalar el módulo, la puerta debe estar en posición cerrada. Fijar el imán en la parte inferior de la puerta y, a continuación, el sensor al mismo nivel (cara con cara). Deje un espacio máximo de 15 mm entre los imanes (no deben tocarse).

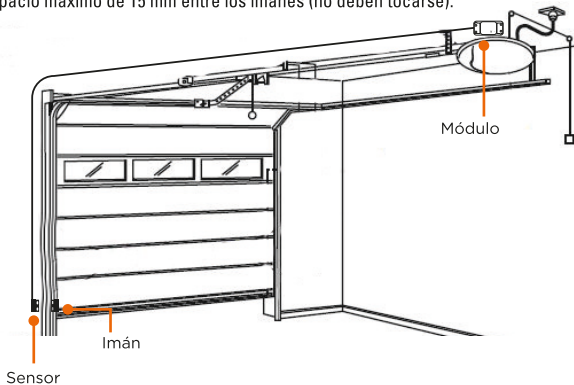

El módulo utiliza el imán y el sensor para indicar si la puerta está cerrada o no.

 **Puerta ABIERTA :**

El sensor ya no detecta el imán. La aplicación indica que la puerta no está cerrada. Puede estar completamente abierta, parcialmente abierta o en proceso de apertura o cierre.

 **Puerta CERRADA :**

El sensor detecta el imán. La aplicación indica que la puerta está completamente cerrada.

IMPORTANTE: La señal de contacto seco es la misma para un disparo de apertura que para un disparo de cierre.

El módulo tendrá en cuenta la última solicitud, en función de la posición de los receptores, para mostrar la información en la aplicación.

La puerta puede moverse en sentido contrario a la indicación en la aplicación. Es importante esperar hasta el final de la animación de la aplicación para conocer el estado real de la puerta (cerrada o no cerrada).

D - CONFIGURACIÓN DE LA APLICACIÓN

D1 - Instalación de la aplicación



iSCS Sentinel

Para descargar la aplicación, acceda a la App Store o Play Store de su smartphone. Busque «iSCS Sentinel» y haga clic en Instalar.



Al final de la descarga, abrir la aplicación y hacer clic en crear mi cuenta



Introducir la dirección de correo electrónico y la contraseña en las casillas correspondientes.

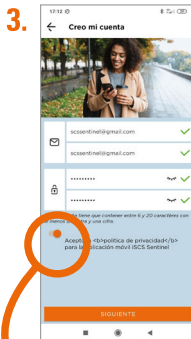

Pulsar «siguiente». Debe aceptar la política de privacidad antes de hacer clic en siguiente.



Introducir el código de validación que ha recibido por correo electrónico. Luego, validar la cuenta.

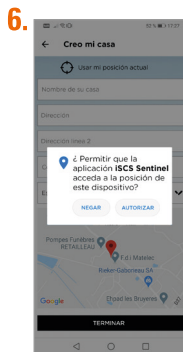
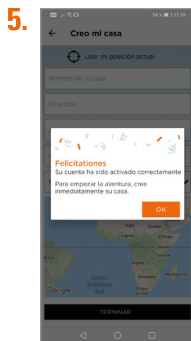

Pulsar **AUTORIZAR**.



Introducir toda la información necesaria para crear la casa. Luego, hacer clic en terminar.

D2 - Añadir el producto

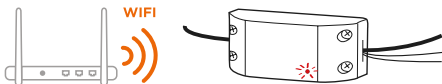

Conectar el módulo y colóquela cerca del rúter Wi-Fi. El teléfono debe estar conectado a la misma red Wi-Fi que el módulo y debe tener activada la localización.

⚠ Algunos materiales pueden reducir el alcance de la señal Wi-Fi.

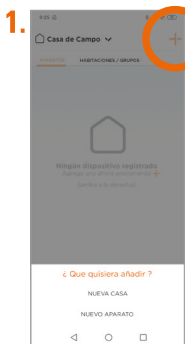
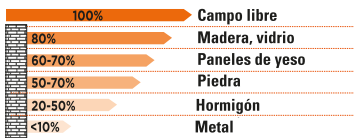

Pulsar **+** y luego «**NUEVO DISPOSITIVO**» para añadir el producto.



Introducir la clave Wi-Fi, escanear el código QR de la parte trasera del monitor o introducir el código manualmente.



La red debe estar en **2,4 GHz** para funcionar.

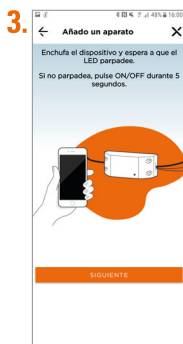

Conectar el aparato y espere a que el LED parpadee. Si no parpadea, pulsar el botón ON/OFF durante 5 segundos.

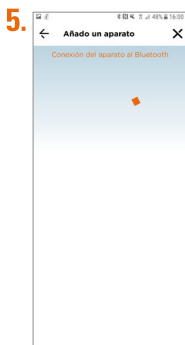

Pulsar +

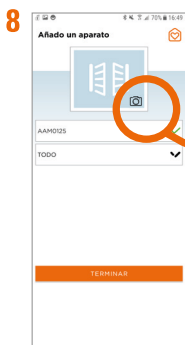
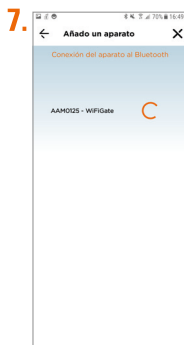

Assegnare un nome al modulo e selezionare il tipo di porta.

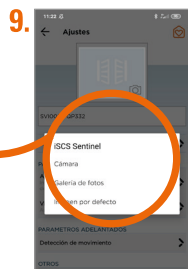

Añadir una foto de perfil desde la cámara, la galería o seleccionar una imagen predeterminada (foto de producto).

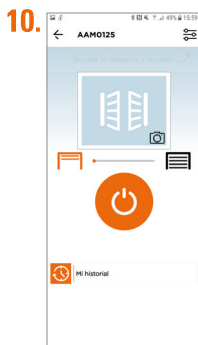

 Si el dispositivo no se conecta a la red Wi-Fi, aparecerá una página de error.

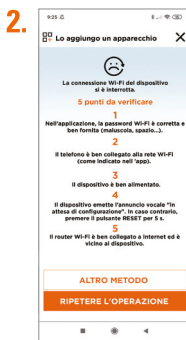

Hacer clic en «Repetir la operación»: volverá al paso 2



Si «Repetir la operación» no funciona, pulsar «Otro método»

Comprobar estos 5 puntos.

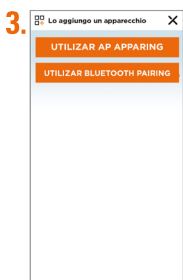

Utilizar «AP pairing»

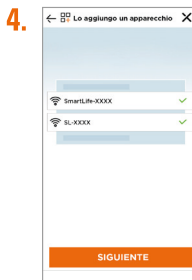

Conectar el teléfono al punto de acceso Wi-Fi del dispositivo.



Activar lentamente: AP pairing

Activar rápidamente: Bluetooth pairing

E- CONFIGURACIÓN

Configuración de la aplicación



Pulsar  para acceder a la configuración de la aplicación.



Ver mi perfil:
Para modificar la información personal.

Para añadir una casa

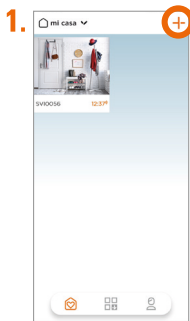

Hacer clic en +

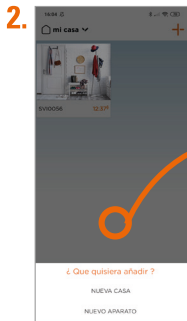

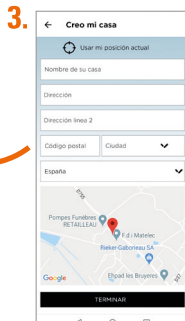

Crear una nueva casa.



Rellene los campos y pulse «FINALIZAR».

Para eliminar una casa

- 

1. Pulsar  para acceder a la configuración de las casas.
- 

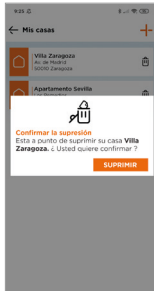

2. Pulsar  para eliminar una casa.
- 

3. Pulsar **SUPRIMIR** para confirmar la eliminación.

Pulsar 

Para modificar una casa

- 

1. Pulsar  para acceder a la configuración de las casas.
- 

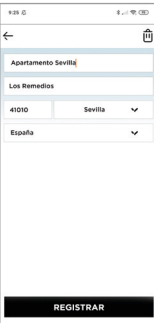

2. Pulsar  para acceder a la configuración de la casa.
- 

3. Pulsar  para modificar la dirección.

Pulsar 

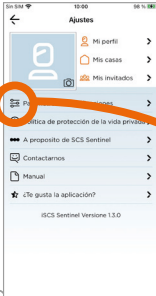
Configuración de las notificaciones

- 

1. Pulsar  para acceder a la configuración de las notificaciones.
- 

2. Pulsar «Activar notificaciones» para activar todas las notificaciones. De lo contrario, pulsar solo las notificaciones que desea recibir.

Uso de la aplicación



Testigo

Pulsar para abrir o cerrar el automatismo



Borrar historia



Seleccionar el tipo de puerta

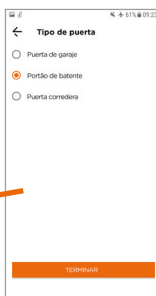

Ajustar el tiempo de apertura de la puerta

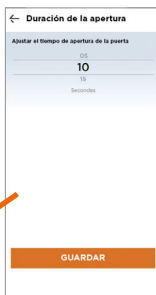



Ejemplo:
Abro mi puerta los días laborales a las 8 de la mañana.



Para seleccionar uno o varios eventos de activación (dispositivo, fecha/hora o lugar) pulsar +

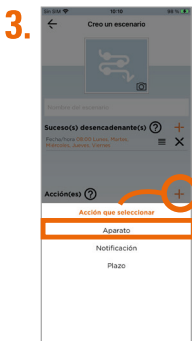

Para seleccionar una o varias acciones (dispositivo, notificación o retardo) pulsar +



Por defecto, el escenario aparece en la lista de favoritos.

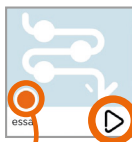

El escenario se activa.

Activar las «acciones» del escenario sin esperar a los «eventos desencadenantes».

●●● Añadir invitados

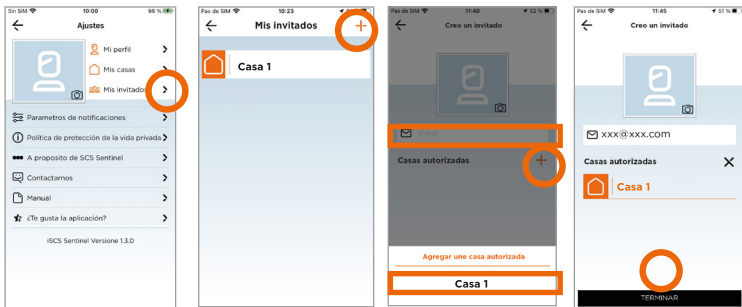

 **A través de la aplicación iSCS Sentinel, un invitado puede activar/desactivar los dispositivos pero no puede**

●●● Control con asistentes de voz



Antes de empezar, asegúrese de que el dispositivo está conectado a la aplicación iSCS Sentinel, que el asistente de voz está conectado a Internet y que funciona correctamente (haga una pregunta para comprobarlo).

Google Assitant

- Abra la aplicación Google Home 
- Haga clic en el icono «+»,
y luego Configurar un dispositivo / función con Google y seleccione iSCS Sentinel.
- Introduzca las credenciales utilizadas para iniciar sesión en la aplicación iSCS Sentinel. El asistente de voz buscará los dispositivos disponibles y los mostrará en la lista de dispositivos de la aplicación Google Home. Si no es así, dígame a su asistente de voz «OK Google, sincroniza dispositivos».

Alexa

- Abra la aplicación Alexa 
- Seleccione Habilidades y luego iSCS Sentinel.
- Introduzca las credenciales utilizadas para iniciar sesión en la aplicación iSCS Sentinel. El asistente de voz buscará los dispositivos disponibles y los mostrará en la lista de dispositivos de la aplicación Alexa.

	 Google Assistant	 Alexa
Abrir la puerta	« Abra puerta* » + código PIN	« Abra puerta* » + código PIN
Cerrar la puerta	« Cerra puerta* »	« Cerra puerta* »

Reset

Para volver a emparejar el módulo, pulsar y mantener el botón durante 10 segundos. Esta operación eliminará el emparejamiento del módulo con su red Wi-Fi.

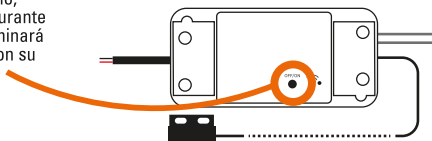

Para eliminar el dispositivo por completo, hay que eliminarlo en la aplicación.

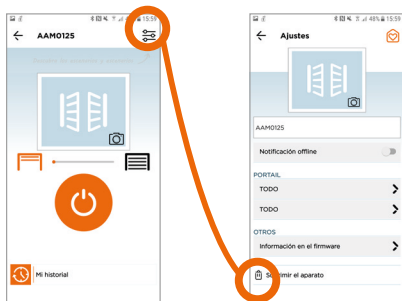

F- CARACTERÍSTICAS TÉCNICAS

Módulo conectado

Alimentación	12V DC 1000mA
Frecuencia de funcionamiento	2412MHz ~ 2472MHz / 2402MHz ~ 2480MHz
Potencia máxima de transmisión	< 100mW
Temperatura de funcionamiento	-10°C ~ +40°C
Dimensiones	88 x 40 x 23 mm

G- ASISTENZA TECNICA

Supporto alla riparazione

Problema	Soluzioni
Non è possibile aggiungere il kit nell'applicazione.	<ul style="list-style-type: none">- Verificare che il dispositivo sia collegato e che il LED del Wi-Fi sia acceso o lampeggiante- Verificare la connessione Wi-Fi- Non inserire spazi bianchi digitando la password- Verificare che la password del Wi-Fi inserita sia corretta- Verificare che il modem sia collegato a internet- Verificare che la localizzazione del telefono sia attiva- Assicurarsi di avere campo sufficiente- Verificare che la rete dello smartphone corrisponda a quella indicata nell'applicazione- Verificare che la rete Wi-Fi sia su 2.4 GHz e non su 5 GHz- Accoppiare i dispositivi a meno di 3 m dal modem Wi-Fi

Consejos de los expertos

Los técnicos del servicio posventa están disponibles en el siguiente número:



937376105

Si el producto funciona mal durante la instalación o pocos días después, póngase en contacto con el servicio de atención al cliente permaneciendo cerca del producto para que nuestros técnicos puedan diagnosticar el problema inmediatamente.

Chat en línea



¿Tiene alguna pregunta?

Para recibir una respuesta personalizada, utilice nuestro chat en línea en nuestra página web www.scs-sentinel.com

H - GARANTÍA



Garantía de 2 años, conforme a la normativa francesa.

Guarde en un lugar seguro el código de barras y su justificante de compra, se le pedirá para poder solicitar la garantía.

Es imprescindible conservar una prueba de compra durante todo el período de garantía.

La garantía no cubre:

- Daños materiales o eléctricos derivados de una instalación incorrecta.
- Daños derivados de un uso inadecuado (uso distinto al original) o de modificaciones.
- Daños resultantes del uso y/o instalación de piezas distintas a las previstas e incluidas por SCS Sentinel.
- Daños debidos a la falta de mantenimiento o caídas.
- Daños debidos a la intemperie, como granizo, rayos, vientos fuertes, etc.
- Devolución de artículos sin copia de la factura o justificante de compra.

I - ADVERTENCIAS

- Mantenga el dispositivo alejado de las llamas, como velas encendidas.
- El funcionamiento normal del producto puede verse afectado por fuertes interferencias electromagnéticas.
- Este equipo está destinado exclusivamente al uso privado.
- El aparato no debe exponerse a goteos ni salpicaduras de agua. No deben colocarse sobre el aparato objetos que contengan líquidos, como jarrones.
- Todos los elementos deben utilizarse en interiores.
- Al tratarse de componentes electrónicos, deben manipularse con cuidado.
- Cuando instale su producto, no deje el embalaje al alcance de niños o animales. Son una fuente potencial de peligro.
- Este producto no es un juguete. No está destinado al uso por parte de niños.



Antes de realizar cualquier tarea de mantenimiento, desenchufe los dispositivos. No limpie el producto con disolventes, sustancias abrasivas o corrosivas. Utilice un simple paño suave. No pulverice nada sobre el producto.



Asegúrese de que su producto está bien cuidado y compruebe con frecuencia si la instalación presenta signos de desgaste. No utilice el aparato si necesita repararlo o ajustarlo. Recorra a personal cualificado.



No deseche los aparatos usados ni las pilas con la basura doméstica. Las sustancias peligrosas que podrían contener pueden ser perjudiciales para la salud y para el medio ambiente. Utilice los medios de recogida selectiva ofrecidos por su ayuntamiento o distribuidor.

Significado de las marcas:

--- Corriente continua



El producto está destinado únicamente para uso en interiores



J- DECLARACIÓN DE CONFORMIDAD

Por la presente, SCS Sentinel declara que este producto cumple los requisitos esenciales y otras disposiciones pertinentes de la Directiva 2014/53/UE. La declaración de conformidad puede consultarse en: www.scs-sentinel.com/downloads.

Toutes les infos sur :
www.scs-sentinel.com



SCS sentinel

110, rue Pierre-Gilles de Gennes
49300 Cholet - France