

# SET RATTAN COMPOSTO DA 1 DIVANO CORNER + 1 TAVOLINO

ISTRUZIONI DI MONTAGGIO  
INSTRUCTIONS D'ASSEMBLAGE

ASSEMBLING INSTRUCTIONS  
AUFBAU ANWEISUNGEN

INSTRUCCIONES DE MONTAJE  
INSTRUÇÕES DE MONTAGEM



15772001



100% Italian ecological evolution

Prodotto da **IGAP spa** nello stabilimento di:  
Via Garibaldi 244 - 46013 CANNETO SULL'OGLIO (Mantova) Italy  
Tel. +039 0376.7172200 - Fax 0376.7172290



100% Italian ecological evolution

## CUSCINI SET RATTAN

AVVERTENZE GENERALI  
NOTICES  
GENERAL NOTICE

ALLGEMEINE AUSKUNFT  
ADVERTENCIAS GENERALES  
INFORMAÇÕES GERAIS



**OPZIONALE!**

- I cuscini sono inclusi solo se previsti dal modello acquistato.
- Les coussins sont ajoutées seulement si ils sont des composantes du modèle acheté.
- Cushions are added only if they are components of the purchased model.
- Die Kissen werden nur hinzugefügt, wenn sie Komponenten des gekauften Modells sind.
- Los cojines se añaden sólo si son componentes del modelo adquirido.
- As almofadas são adicionadas somente se eles são componentes do modelo comprado.

### ATTENZIONE

Lavare le federe soltanto a mano ed in acqua fredda

### ATTENTION

Laver les housses à la main et à l'eau froide seulement

### ATTENTION

Hand wash the covers with cold water only

### ACHTUNG

Kissenbezüge nur mit Hand in kaltem Wasser waschen.

### ATENCIÓN

Lavar fundas a mano en agua fría

### ATENÇÃO

Lavar as capas das almofadas à mão em água fria

# TAVOLINO SET RATTAN

ELENCO ACCESSORI PER IL TAVOLINO  
LISTE DES PIÈCES POUR LA TABLE  
LIST OF PIECES FOR THE TABLE  
LISTE DER TEILE FÜR DEN TISCH  
ELENCO DE LOS ACCESORIOS PARA LA MESA  
LISTA DE ACESSÓRIOS POR LA MESA BAIXA

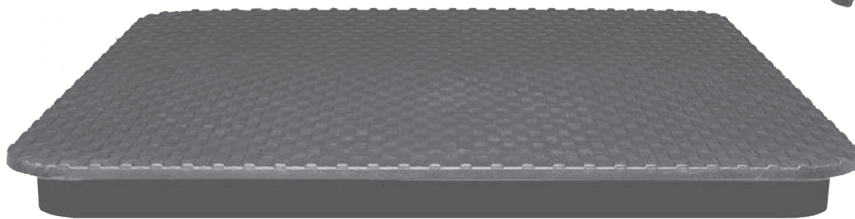
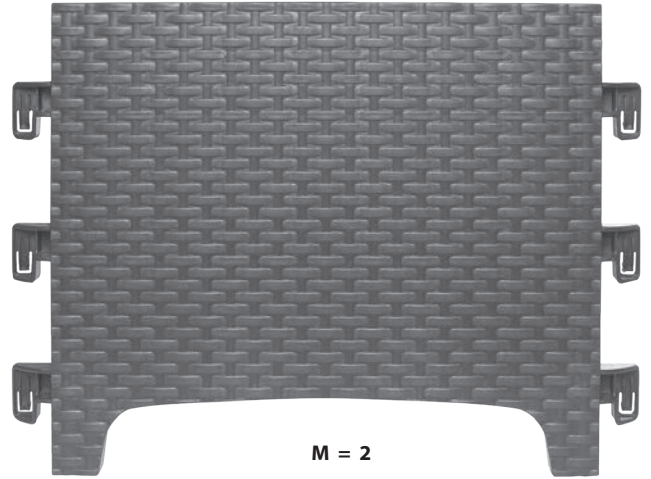
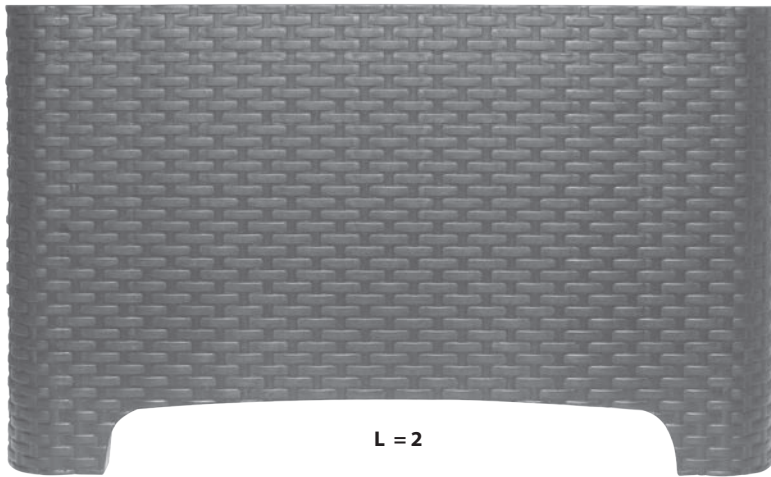

SEGUE  
NEXT 

**IMPORTANT!** CONSERVARE PER FUTURI RIFERIMENTI:  
LEGGERE ATTENTAMENTE.

USO DOMESTICO E CONTRACT

Prodotto in plastica

NON ESPORRE a + 50°C e - 0°

Usare su una superficie piana.

Pulire con acqua e sapone, NON USARE SOLVENTI .

**IMPORTANT!** KEEP FOR FUTURE REFERENCE:  
READ CAREFULLY.

DOMESTIC AND CONTRACT USE

Plastic product

DO NOT EXPOSE to + 50°C and - 0°

Use on a level surface.

Clean using soap and water, DO NOT USE SOLVENTS.

**IMPORTANT!** À CONSERVER POUR CONSULTATION  
ULTÉRIEURE : À LIRE ATTENTIVEMENT.

POUR USAGE DOMESTIQUE ET COLLECTIVITE

Produit en plastique

NE PAS EXPOSER à + 50°C et à - 0°

A utiliser sur un support plan.

Nettoyer avec eau et savon, NE PAS UTILISER DE SOLVANTS.

**WICHTIG!** BITTE AUFMERKSAM DURCHLESEN  
UND GUT AUFBEWAHREN.

FÜR DEN HEIMGEBRAUCH UND KOLLEKTIVITÄT

Kunststoffprodukt

KEINER TEMPERATUR AUSSETZEN, die über 50°C oder  
unter -0°C liegt - Eine ebene Oberfläche verwenden.

Mit Wasser und Seife reinigen, KEINE LÖSUNGSMITTEL VERWENDEN.

**IMPORTANT!** GUARDAR PARA FUTURAS CONSULTAS:  
LEER ATENTAMENTE.

USO DOMESTICO Y CONTRACT

Producto de plástico

NO EXPONGA a + 50°C y - 0°

Use sobre una superficie plana.

Limpie con agua y jabón, NO USE SOLVENTES.

**IMPORTANT!** CONSERVE-O PARA CONSULTAS FUTURAS:  
LER ATENTAMENTE.

UTILIZAÇÃO DOMESTICO E CONTRACT

Produto de plástico

NÃO EXPOR a + 50°C e - 0°

Usar sobre uma superfície plana.

Limpar com água e sabão, NÃO USAR SOLVENTES .

· Le eventuali leggere differenze di colore tra i vari componenti sono dovute alla natura ecologica della materia prima che usiamo · Any slight color differences between the various components are due to the ecological nature of the raw material that we use. · Les éventuelles légères différences de coloris entre les différents composants sont dues à la nature écologique de la matière première que nous utilisons. · Aufgrund der natürlichen Beschaffenheit unserer Materialien sind geringfügige Unterschiede der Farben bei verschiedenen Komponenten möglich. · Las ligeras diferencias de color entre los varios componentes son debidas a la naturaleza ecológica de la materia prima que usamos. · "A eventual existência de pequenas diferenças de cor entre os diversos componentes, é devido à natureza ecológica das matérias primas utilizadas."

# ISTRUZIONI DI MONTAGGIO

ISTRUZIONI DI MONTAGGIO  
INSTRUCTIONS D'ASSEMBLAGE  
ASSEMBLING INSTRUCTIONS  
AUFBAU ANWEISUNGEN  
INSTRUCCIONES DE MONTAJE  
INSTRUÇÕES DE MONTAGEM

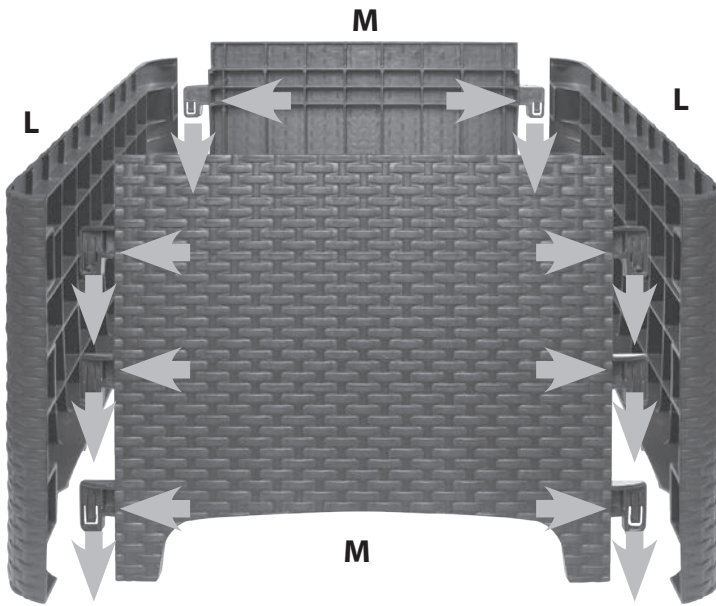

1



2

3

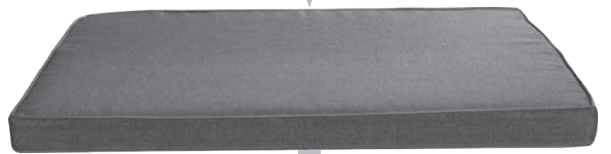
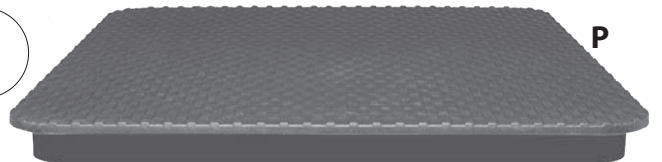

R



4

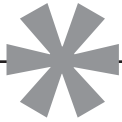
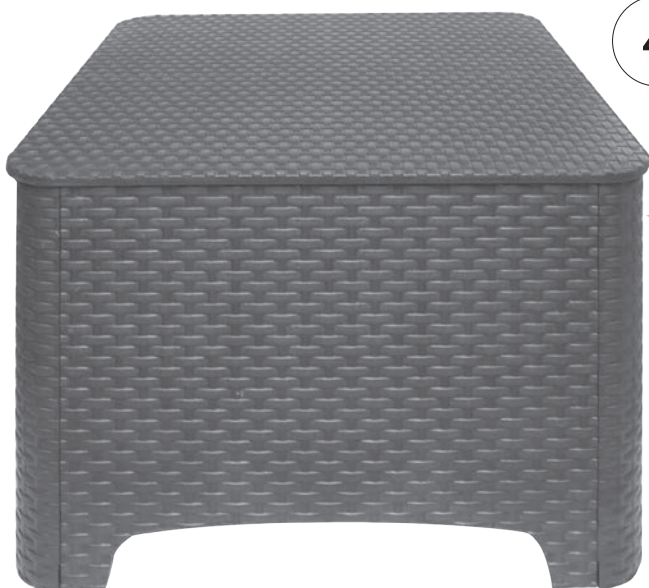

**ATTENZIONE!** il fondo del tavolino (R) sostiene esclusivamente il peso dei cuscini

**ATTENTION!** The base of the table supports (R) just the weight of the cushions

**ATTENTION!** Le support plastique à l'intérieur de la table/coffre-coussins (R) ne permet de supporter que le poids des coussins

**ACHTUNG!** Die Unterseite des Tisches (R) unterstützt nur das Gewicht der Kissen

**ATENCIÓN!** La parte inferior de la mesita (R) solo soporta el peso de los cojines

**ATENÇÃO!** A base inferior da mesa (R) suporta somente o peso das almofadas.

# SET RATTAN CORNER

ELENCO ACCESSORI PER IL DIVANO  
 LISTE DES PIÈCES POUR LE DIVAN  
 LIST OF PIECES FOR THE SOFA  
 LISTE DER TEILE FÜR DAS SOFA  
 ELENCO DE LOS ACCESORIOS PARA EL DIVAN  
 LISTA DE ACESSÓRIOS POR O SOFÀ

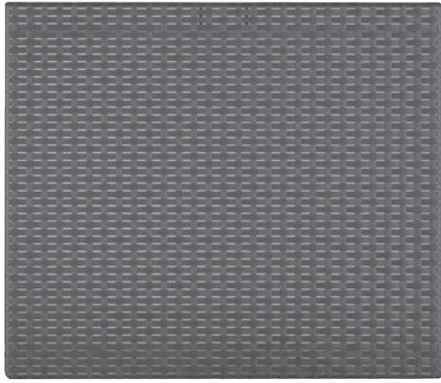

G = 4

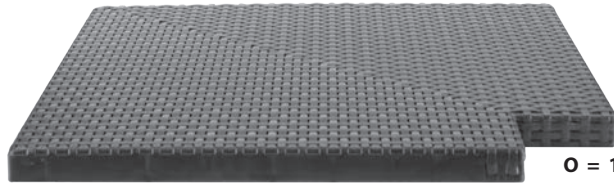

O = 1

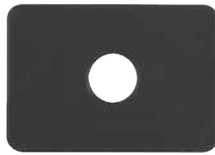

C = 14

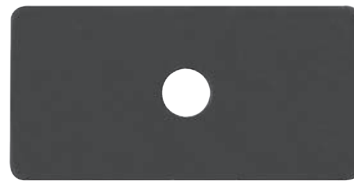

I = 12



K = 32



D = 6

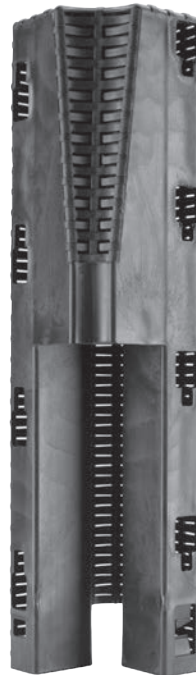

T = 1

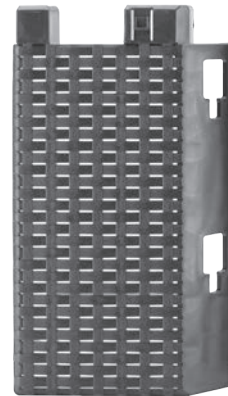

U = 1

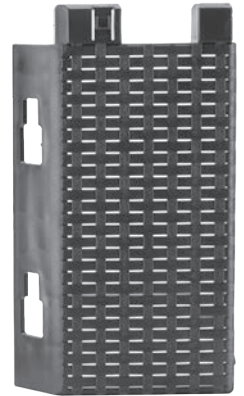

Q = 1

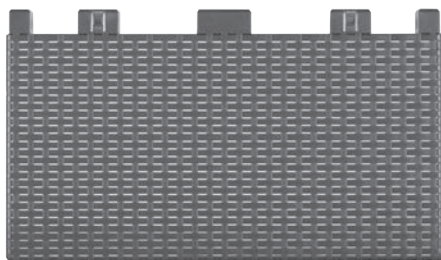

H = 4

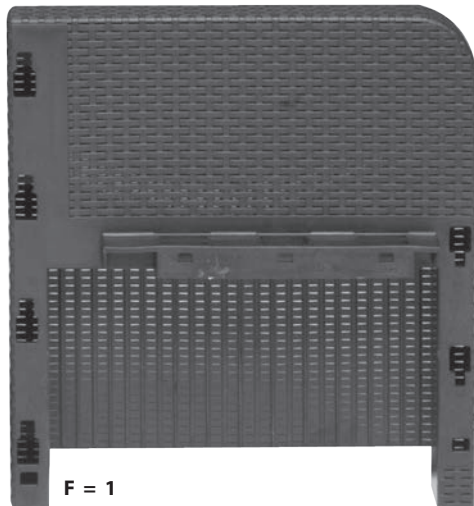

F = 1



N = 4



J = 16



E = 1

# SET RATTAN CORNER

ISTRUZIONI DI MONTAGGIO PER IL DIVANO  
INSTRUCTIONS D'ASSEMBLAGE POUR LE DIVAN  
ASSEMBLING INSTRUCTIONS FOR THE SOFA  
AUFBAU ANWEISUNGEN FUER DAS SOFA  
INSTRUCCIONES DE MONTAJE PARA EL DIVAN  
INSTRUÇÕES DE MONTAGEM POR O SOFÀ

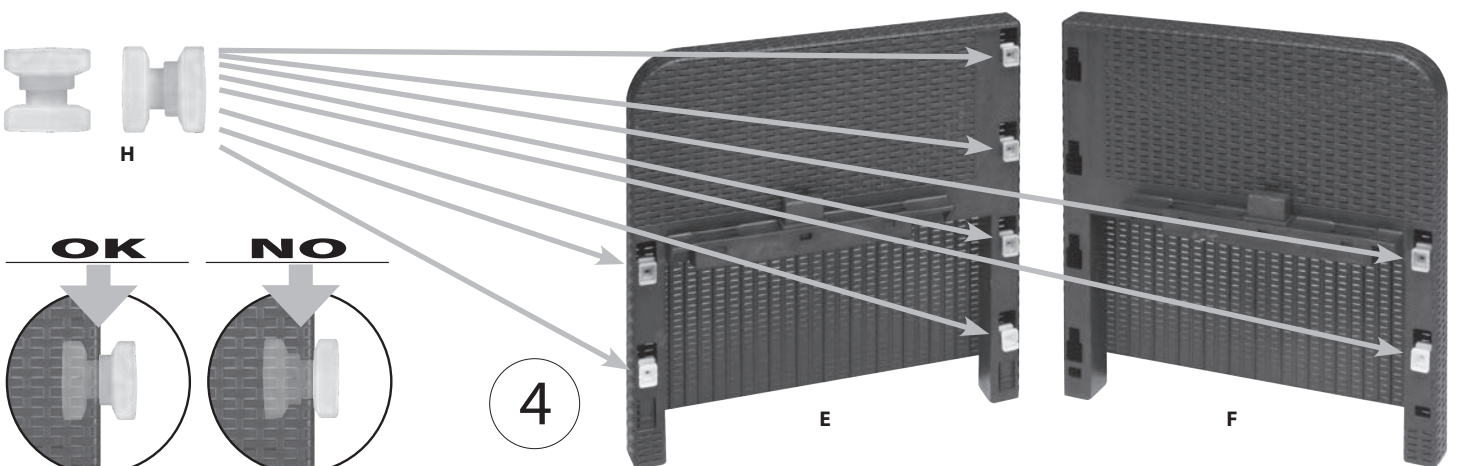
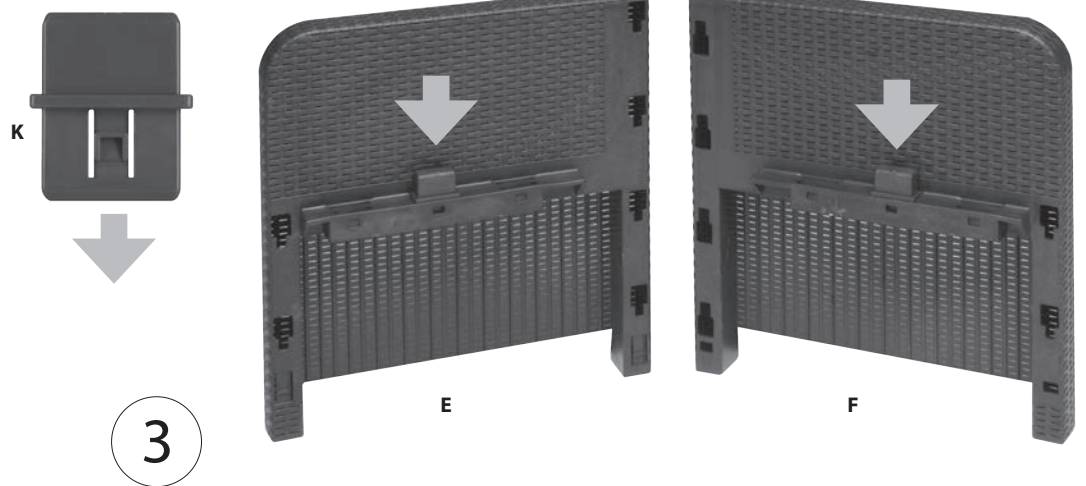
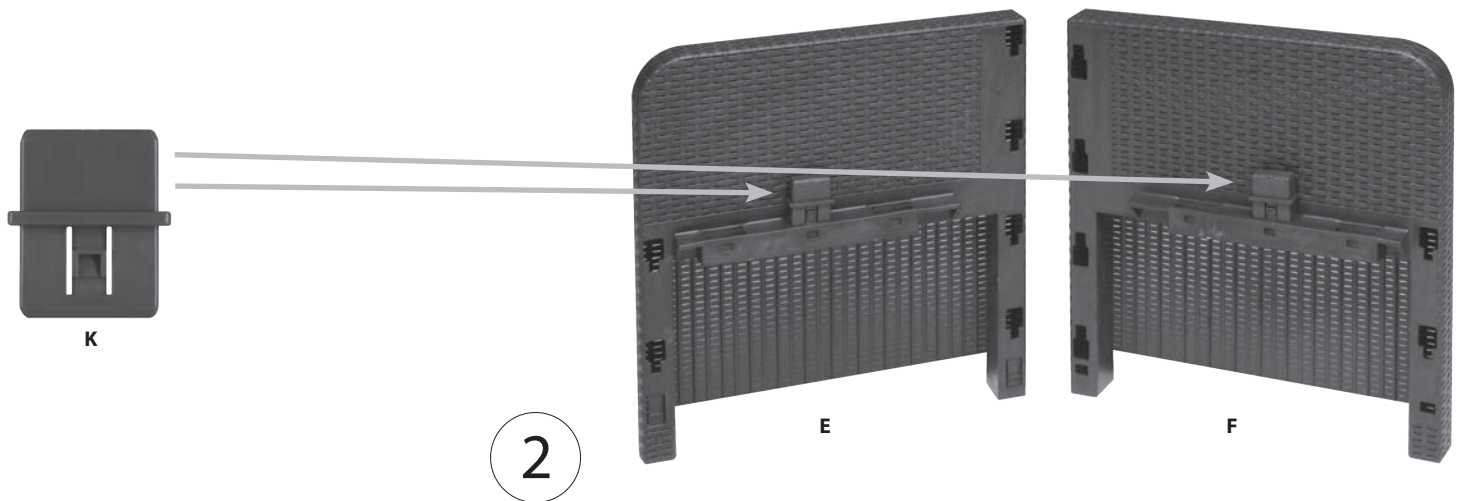
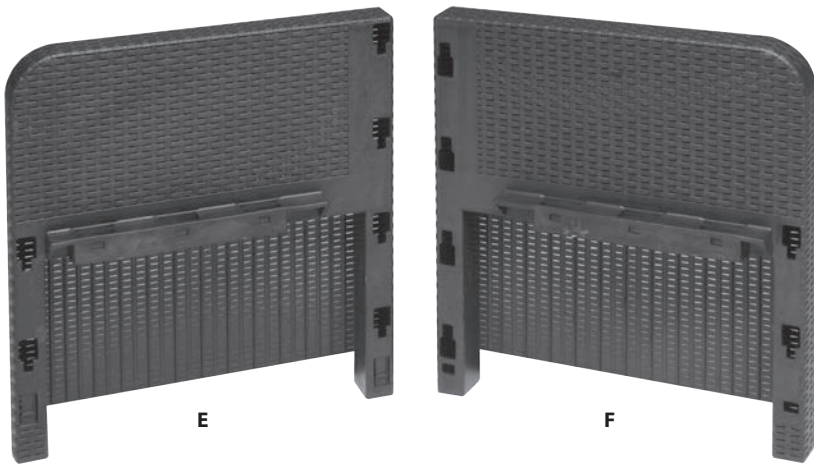

# SET RATTAN CORNER

ISTRUZIONI DI MONTAGGIO PER IL DIVANO  
INSTRUCTIONS D'ASSEMBLAGE POUR LE DIVAN  
ASSEMBLING INSTRUCTIONS FOR THE SOFA  
AUFBAU ANWEISUNGEN FÜR DAS SOFA  
INSTRUCCIONES DE MONTAJE PARA EL DIVAN  
INSTRUÇÕES DE MONTAGEM POR O SOFÀ



ELEMENTO **D** - 3 + 3 PEZZI  
ÉLÉMENT **D** - 3 + 3 PIÈCES  
ELEMENT **D** - 3 + 3 PIECES  
ELEMENT **D** - 3 + 3 STÜCK  
ELEMENTO **D** - 3 + 3 PIEZAS  
ELEMENTO **D** - 3 + 3 PEÇAS



5

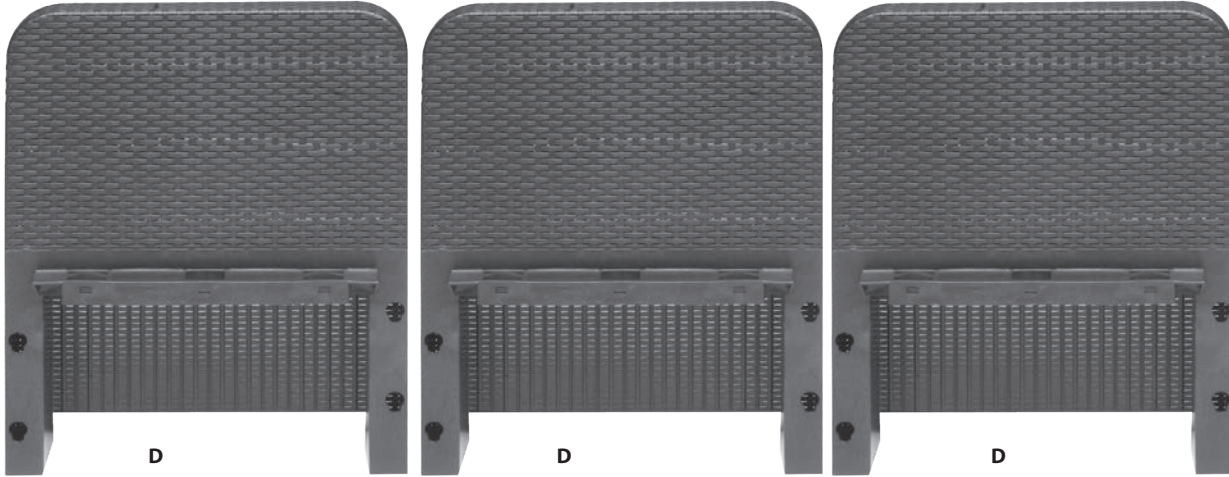

J

6

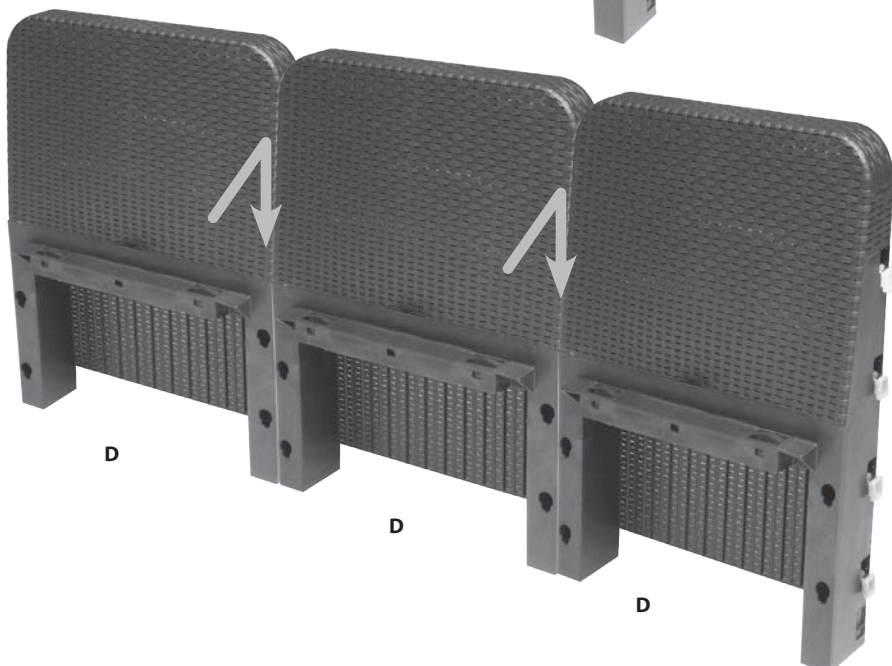
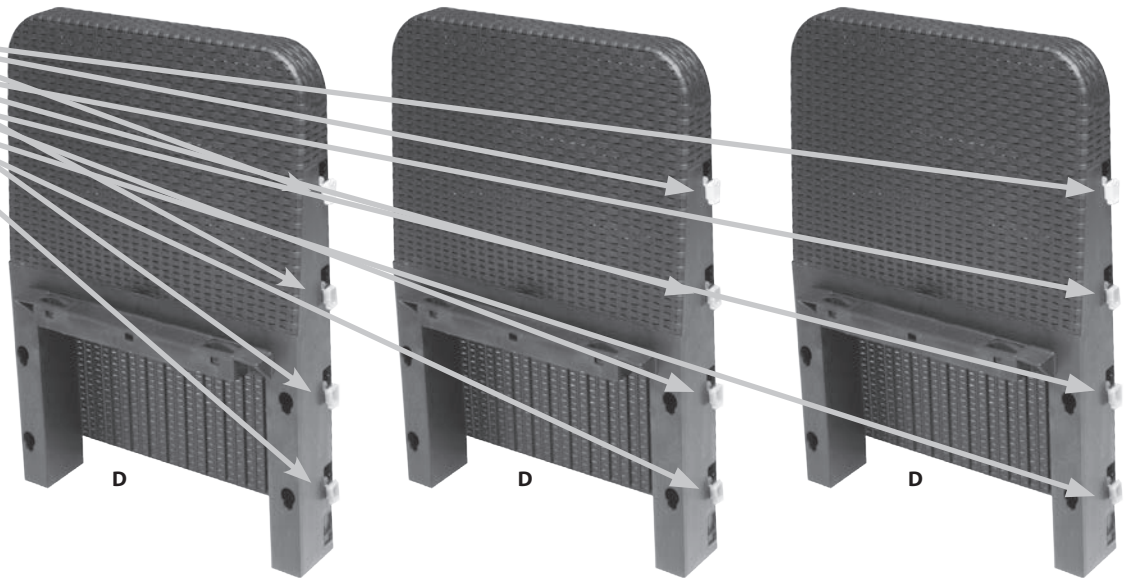

7

# SET RATTAN CORNER

ISTRUZIONI DI MONTAGGIO PER IL DIVANO  
INSTRUCTIONS D'ASSEMBLAGE POUR LE DIVAN

ASSEMBLING INSTRUCTIONS FOR THE SOFA  
AUFBAU ANWEISUNGEN FÜR DAS SOFA  
INSTRUCCIONES DE MONTAJE PARA EL DIVAN  
INSTRUÇÕES DE MONTAGEM POR O SOFÀ

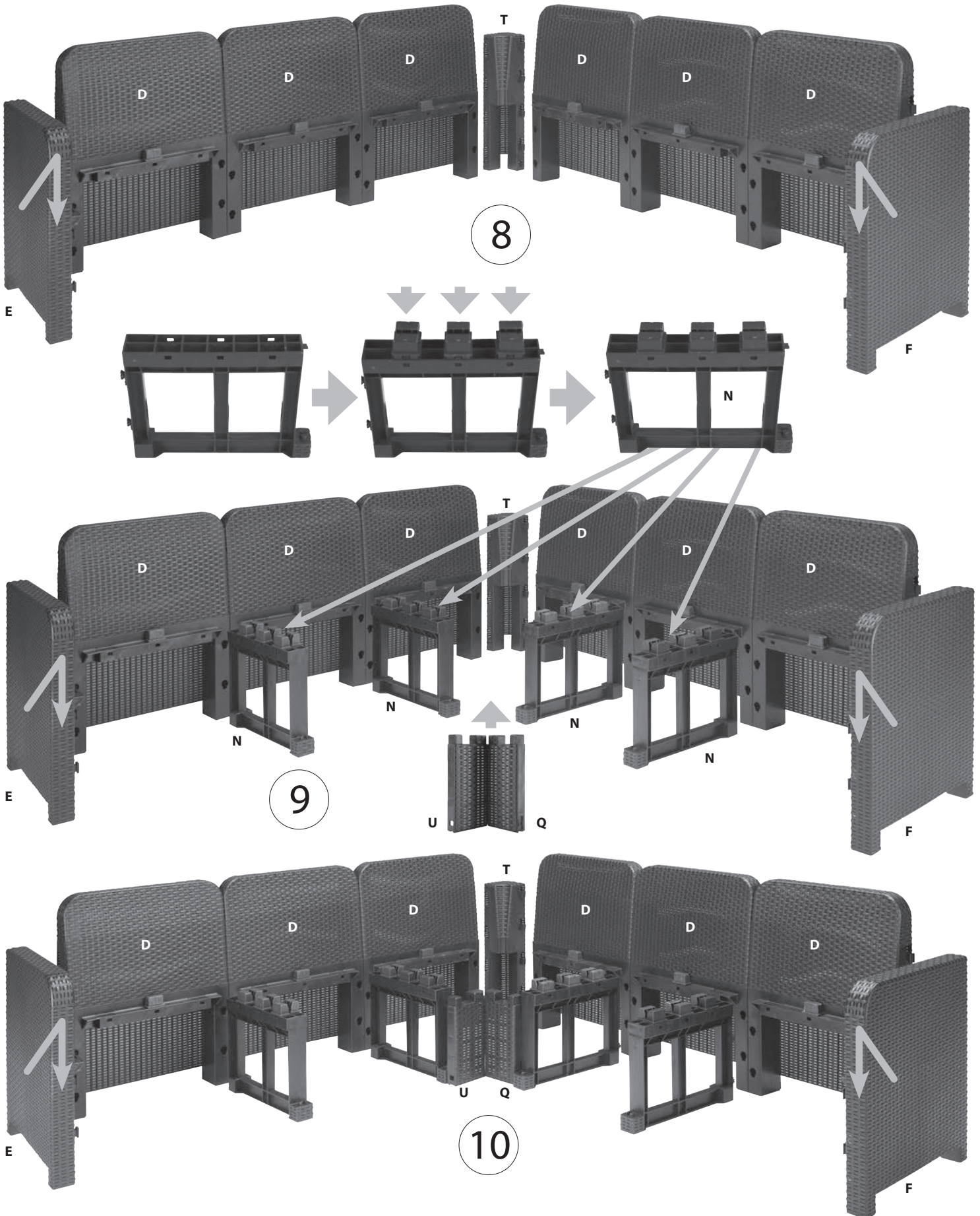

# SET RATTAN CORNER

ISTRUZIONI DI MONTAGGIO PER IL DIVANO  
INSTRUCTIONS D'ASSEMBLAGE POUR LE DIVAN

ASSEMBLING INSTRUCTIONS FOR THE SOFA  
AUFBAU ANWEISUNGEN FÜR DAS SOFA  
INSTRUCCIONES DE MONTAJE PARA EL DIVAN  
INSTRUÇÕES DE MONTAGEM POR O SOFÀ

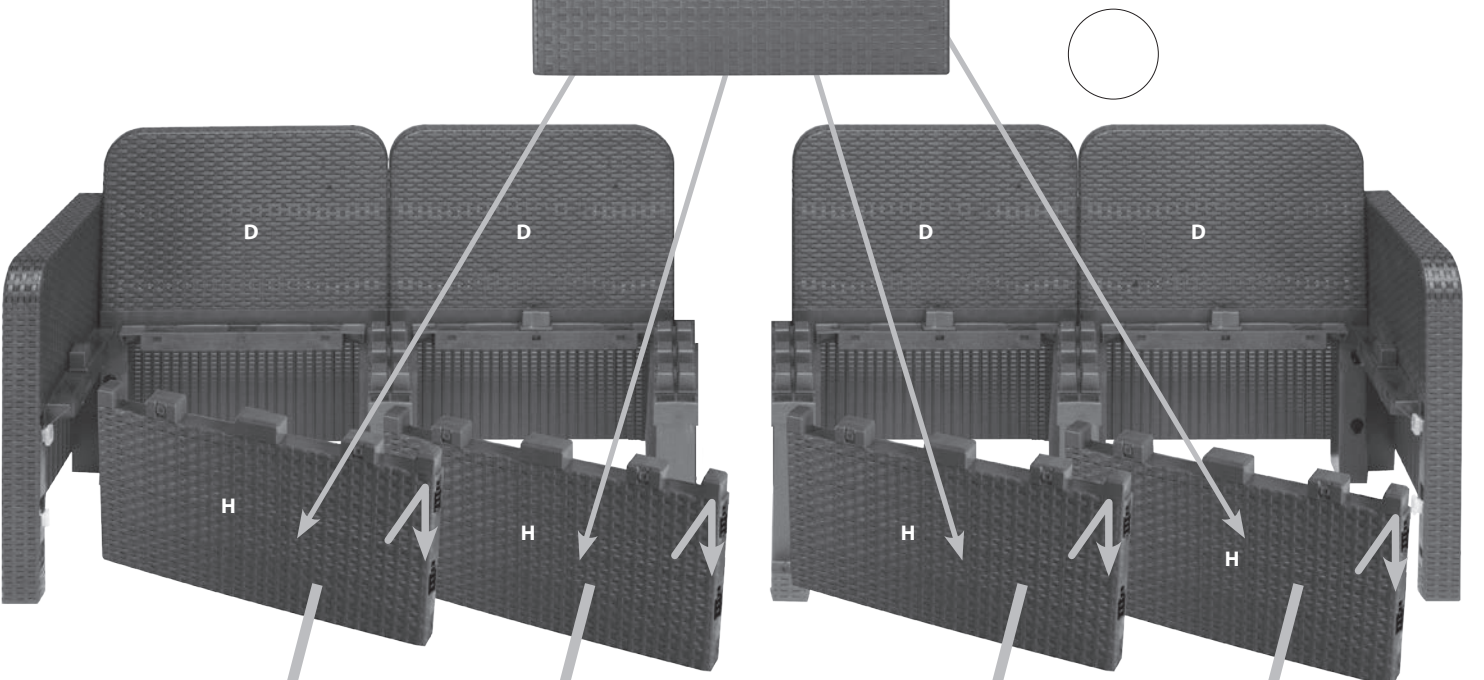

11

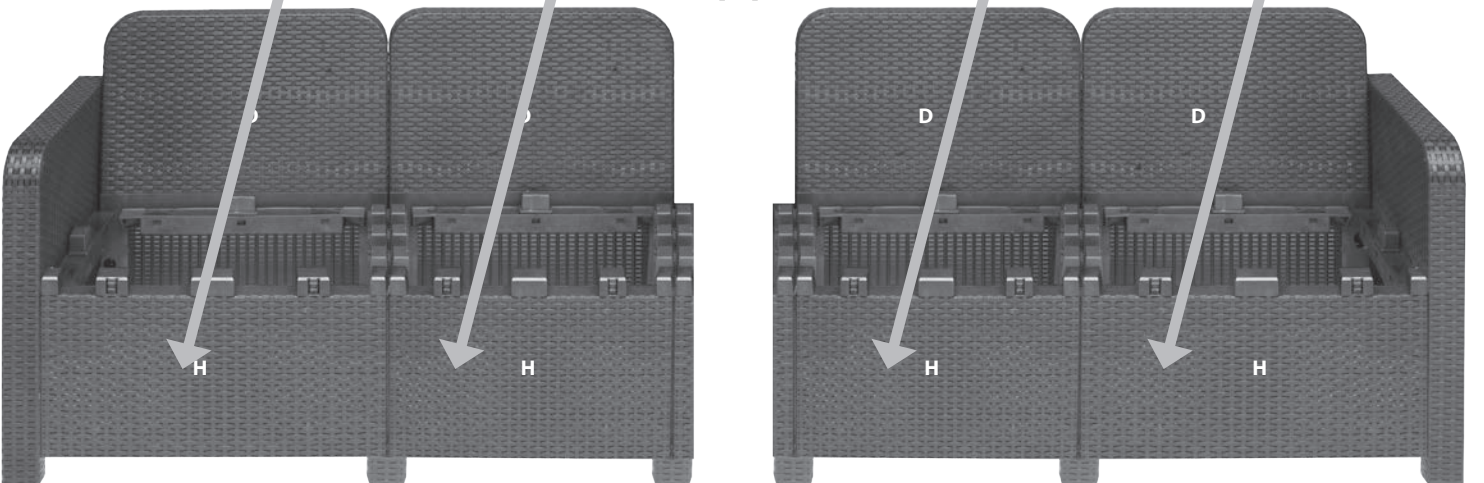



# SET RATTAN CORNER

ISTRUZIONI DI MONTAGGIO PER IL DIVANO  
INSTRUCTIONS D'ASSEMBLAGE POUR LE DIVAN  
ASSEMBLING INSTRUCTIONS FOR THE SOFA  
AUFBAU ANWEISUNGEN FÜR DAS SOFA  
INSTRUCCIONES DE MONTAJE PARA EL DIVAN  
INSTRUÇÕES DE MONTAGEM POR O SOFÀ

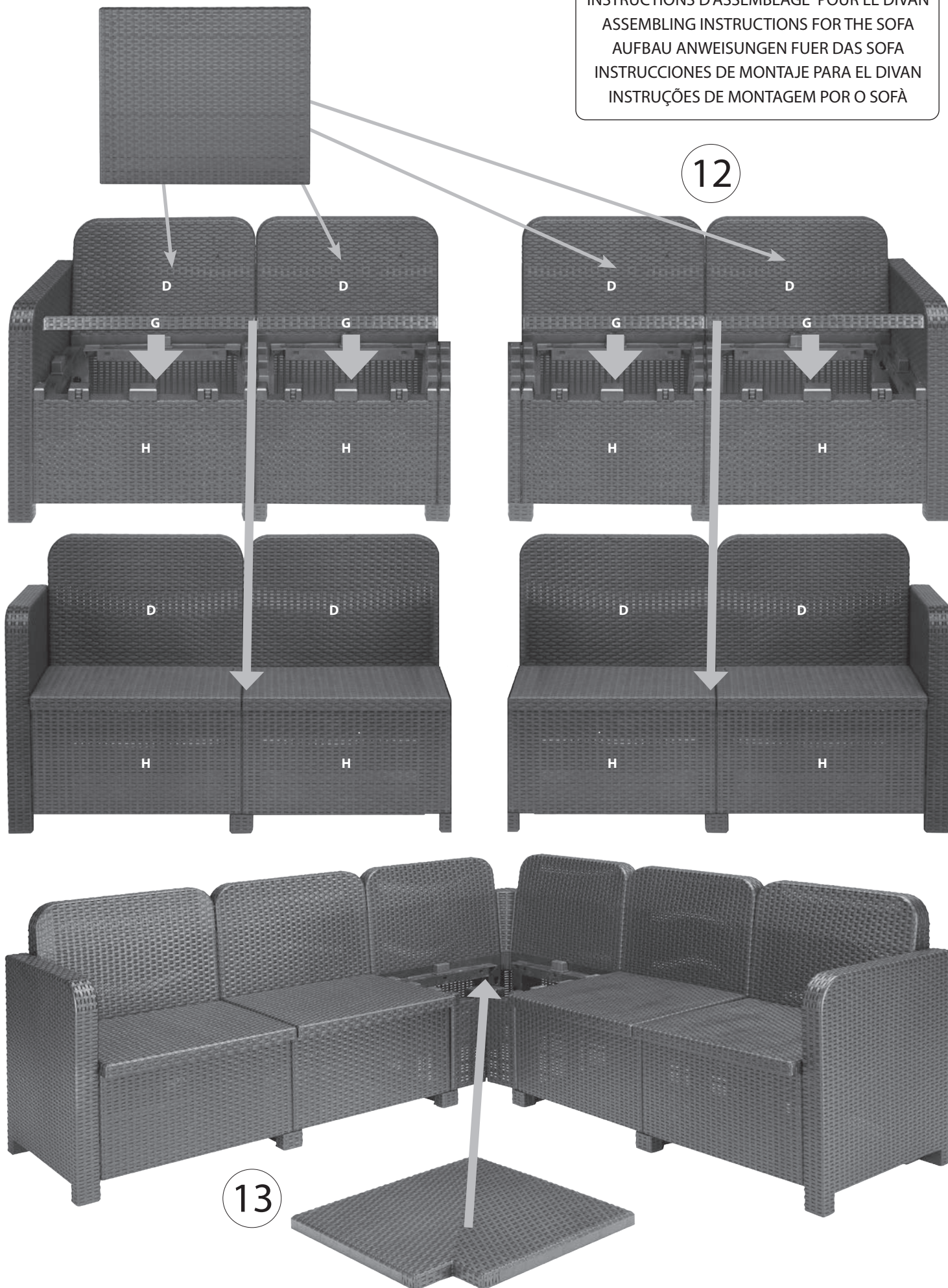

# SET RATTAN CORNER

ISTRUZIONI DI MONTAGGIO PER IL DIVANO  
INSTRUCTIONS D'ASSEMBLAGE POUR LE DIVAN

ASSEMBLING INSTRUCTIONS FOR THE SOFA  
AUFBAU ANWEISUNGEN FUER DAS SOFA  
INSTRUCCIONES DE MONTAJE PARA EL DIVAN  
INSTRUÇÕES DE MONTAGEM POR O SOFÀ

