







- FR: Spot encastré Atlas
- EN: Downlight Atlas
- DE: Einbauleucht Atlas
- IT: Spot da incasso Atlas
- ES: Lugar empotrado Atlas
- PL: Plamka świecąca utwierdzić Atlas



					
3297027315720	5W	600lm	2700-3000-4000K	68mm	9x5,6 cm

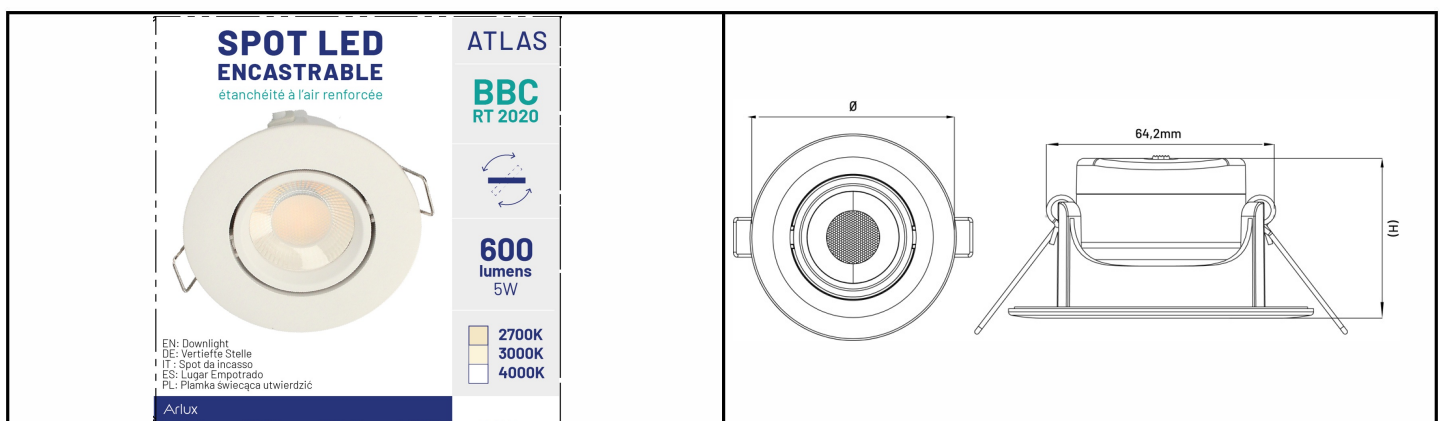

ARLUX

Traverse de la Bastidonne - 13400 Aubagne.

Tel: +33 (0)4 91 02 50 90 | Fax: +33 (0)4 91 93 74 59 | [srvcom@arlux-lighting.fr](mailto:srvcom@arlux-lighting.fr)

SAS au Capital de 800 000 euros | RCS Marseille 489 327 148